

Serie VF



Manuale di riparazione
Repair Manual
Manuel de réparation
Reparaturanleitung
Manual de reparación
Manual de reparação

Sommario

1	INTRODUZIONE.....	3
1.1	DESCRIZIONE SIMBOLI	3
2	NORME DI RIPARAZIONE	3
2.1	RIPARAZIONE DELLA PARTE MECCANICA	3
2.1.1	<i>Smontaggio della parte meccanica</i>	3
2.1.2	<i>Rimontaggio della parte meccanica</i>	5
2.1.3	<i>Classi di minorazioni previste</i>	7
2.1.4	<i>Smontaggio / rimontaggio cuscinetti e rasamenti</i>	7
2.2	RIPARAZIONE DELLA PARTE IDRAULICA	8
2.2.1	<i>Smontaggio testata-gruppi valvole</i>	8
2.2.2	<i>Rimontaggio della testata - camicie - valvole</i>	10
2.2.3	<i>Smontaggio del gruppo pistone - supporti - tenute</i>	10
2.2.4	<i>Rimontaggio del gruppo pistone - supporti - tenute</i>	12
3	TARATURE SERRAGGIO VITI	14
4	SOSTITUZIONE BOCCOLA PIEDE BIELLA.....	16
5	ATTREZZI PER LA RIPARAZIONE	16

1 INTRODUZIONE

Questo manuale descrive le istruzioni per la riparazione delle pompe famiglia VF e deve essere attentamente letto e compreso prima di effettuare ed eseguire qualsiasi intervento sulla pompa.

Dal corretto uso e dalle adeguate manutenzione dipende il regolare funzionamento e durata della pompa.

Interpump Group declina ogni responsabilità per danni causati da negligenza e mancata osservazione delle norme descritte in questo manuale.

1.1 DESCRIZIONE SIMBOLI

Leggere attentamente quanto riportato in questo manuale prima di ogni operazione.



Segnale di Avvertenza



Leggere attentamente quanto riportato in questo manuale prima di ogni operazione.



Segnale di Pericolo

Munirsi di occhiali protettivi.



Segnale di Pericolo

Munirsi di guanti protettivi prima di ogni operazione.

2 NORME DI RIPARAZIONE



2.1 RIPARAZIONE DELLA PARTE MECCANICA

Le operazioni di riparazione della parte meccanica devono essere eseguite dopo aver tolto l'olio dal carter.

Per togliere l'olio occorre rimuovere: l'asta livello olio pos. ① e successivamente il tappo pos. ②, Fig. 1.

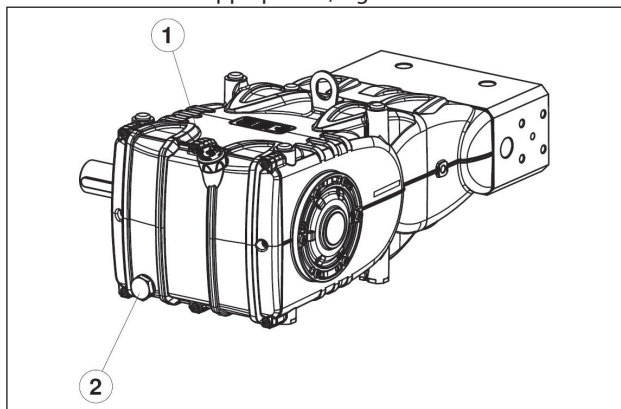

Fig. 1



L'olio esausto deve essere messo in un apposito recipiente e smaltito negli appositi centri. Non deve essere assolutamente disperso nell'ambiente.

2.1.1 Smontaggio della parte meccanica

Le operazioni descritte vanno eseguite dopo avere rimosso la parte idraulica, i pistoni ceramici ed i paraspruzzi dalla pompa (par. 2.2.3, 2.2.4).

Per una corretta sequenza smontare nel seguente ordine:

- la linguetta dell'albero pompa
- il coperchio posteriore
- il cappello delle bielle nel modo seguente: svitare le viti fissaggio cappello, estrarre i cappelli biella con relativi semicuscinetti inferiori (Fig. 2) prestando attenzione nello smontaggio alla relativa sequenza numerata.

Per evitare possibili errori, cappelli e fusti biella sono stati numerati su un fianco (Fig. 2/a, pos. ①).

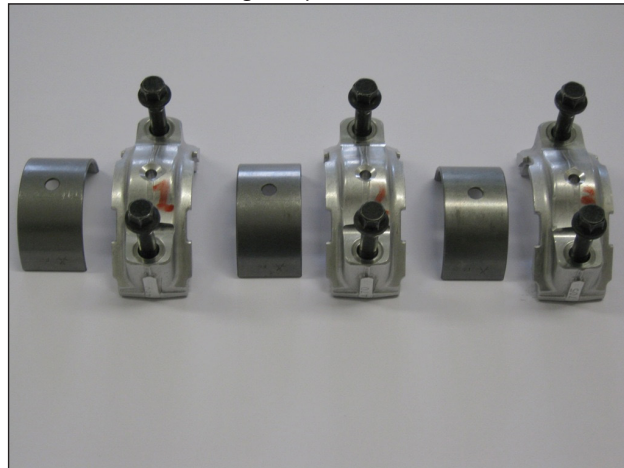

Fig. 2

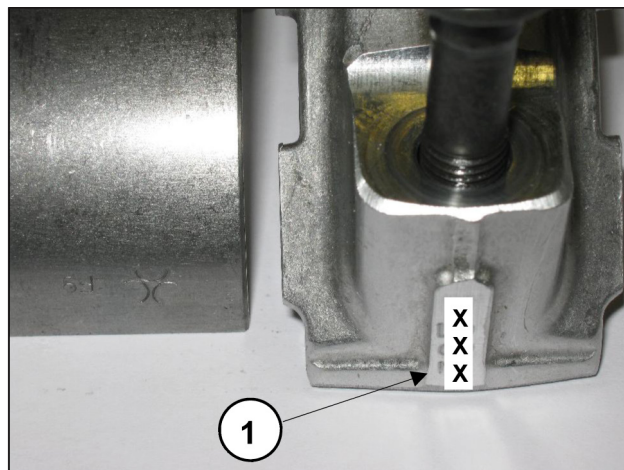

Fig. 2/a

- i coperchi laterali utilizzando - per l'estrazione N°3 viti M6x50 interamente filettate inserendole nei fori filettati come indicato in Fig. 3.

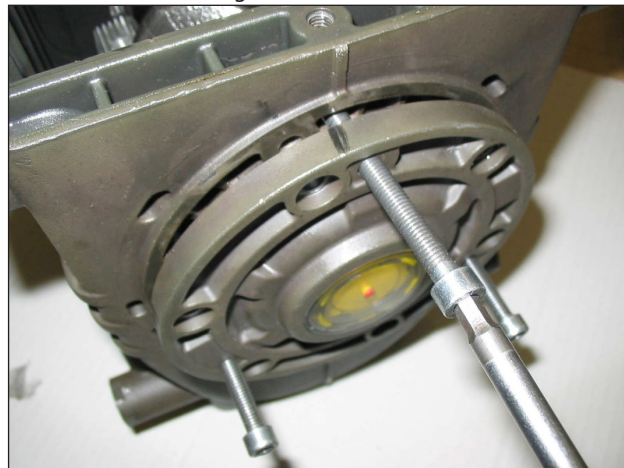

Fig. 3

- Spingere in avanti le guide pistone con le relative bielle per facilitare l'estrazione laterale dell'albero pompa. Sull'albero sono visibili due riferimenti (indicati con 1 nelle Fig. 4 e Fig. 4/a), essi devono essere rivolti verso l'operatore in modo da facilitarne l'estrazione.

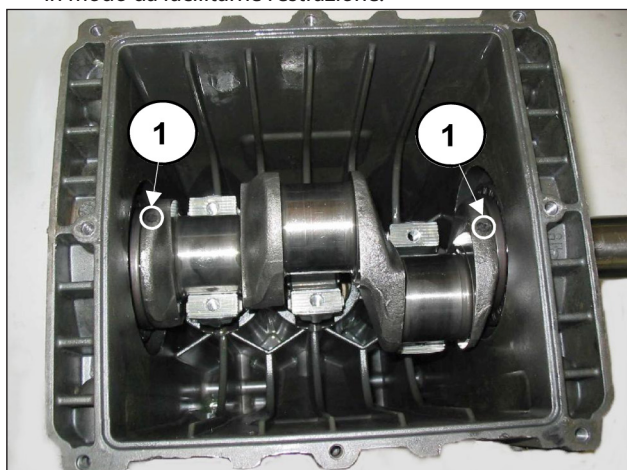

Fig. 4

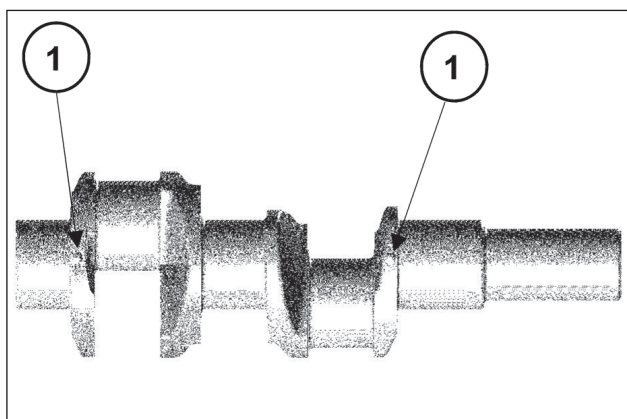

Fig. 4/a

- Estrarre l'albero pompa
- Completare lo smontaggio dei gruppi biella estraendoli dal carter pompa e rimuovendo gli spinotti dalle guide pistone.
- Smontare gli anelli di tenuta albero pompa con attrezzi comuni.
- Smontare gli anelli di tenuta guide pistone seguendo la procedura descritta: utilizzare l'estratteore cod. 26019400 (Fig. 5, pos. ①) e la pinza cod. 27503900 (Fig. 5, pos. ②). Inserire la pinza fino a battuta sull'anello di tenuta con l'ausilio di un martello (Fig. 5/a), successivamente avvitare l'estratteore alla pinza ed agire sulla massa battente dell'estratteore (Fig. 5/b) fino ad estrarre l'anello da sostituire (Fig. 5/c).

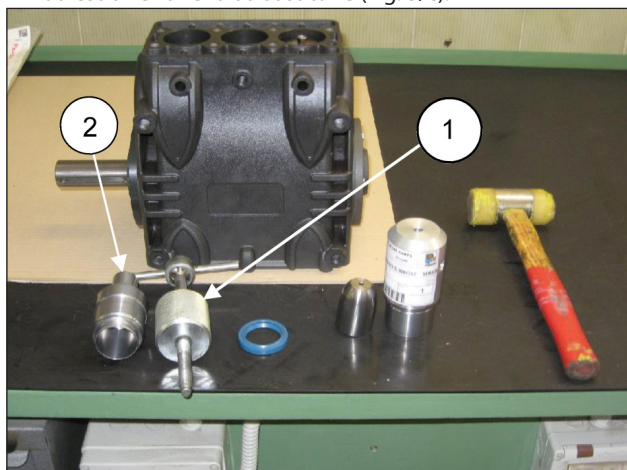

Fig. 5



Fig. 5/a



Fig. 5/b



Fig. 5/c

2.1.2 Rimontaggio della parte meccanica

Dopo aver verificato la pulizia del carter, procedere al montaggio della parte meccanica rispettando la procedura descritta:



- Montare i semicuscinetti superiori ed inferiori nelle rispettive sedi delle bielle e dei cappelli. **Assicurarsi che le tacche di riferimento dei semicuscinetti superiore (Fig. 6, pos. ①) ed Inferiore (Fig. 6/a, pos. ②) vengano posizionate nelle rispettive sedi della biella e del cappello.**

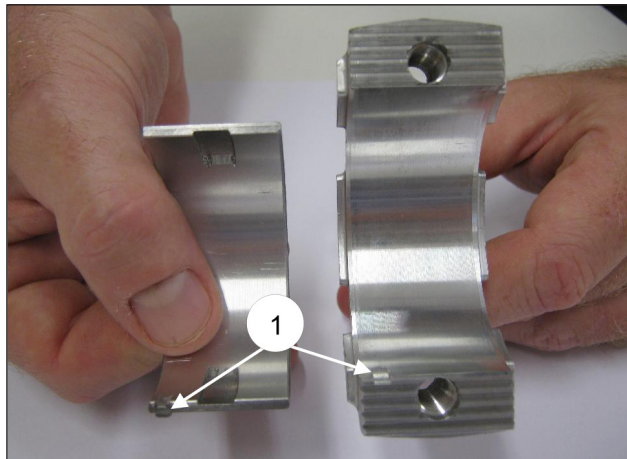

Fig. 6

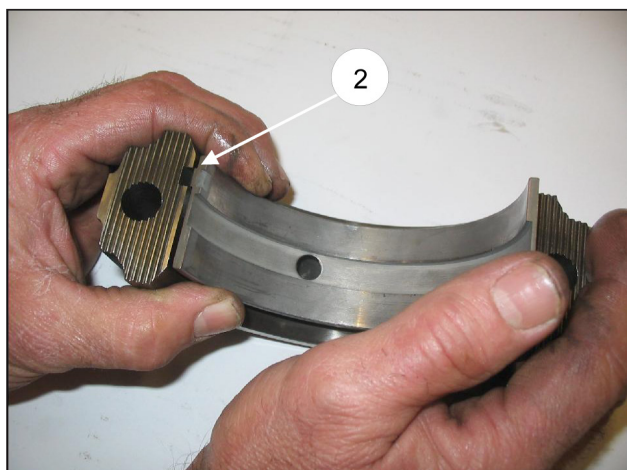

Fig. 6/a

- Introdurre nel carter pompa i gruppi guida pistone / biella orientando la numerazione presente sul fusto biella verso l'alto del carter.

Per facilitare l'introduzione dell'albero pompa (privo di linguetta) è indispensabile ripetere l'operazione effettuata allo smontaggio spingendo in fondo i gruppi guida pistone / biella (par. 2.1.1).

- Prima di procedere al montaggio del coperchio laterale lato P.T.O. verificare le condizioni del labbro di tenuta dell'anello radiale e della relativa zona di contatto sull'albero.

Se si rende necessaria la sostituzione, posizionare il nuovo anello utilizzando l'attrezzo (cod. 27904800) come indicato in Fig. 7.



Qualora l'albero pompa presenti un'usura diametrica nella zona di contatto col labbro di tenuta, al fine di evitare l'operazione di rettifica, è possibile riposizionare l'anello in battuta col coperchio come indicato nella Fig. 7.

Prima di montare i coperchi laterali assicurarsi della presenza degli O-ring di tenuta su entrambi e degli anelli di rasamento sul solo coperchio lato spia.

Per facilitare l'imbocco del primo tratto ed il relativo inserimento dei coperchi sul carter, si consiglia l'utilizzo di N° 3 viti M6 x 40 parzialmente filettate, (Fig. 8, pos. ①) per poi completare l'operazione con le viti in dotazione (M6x18).

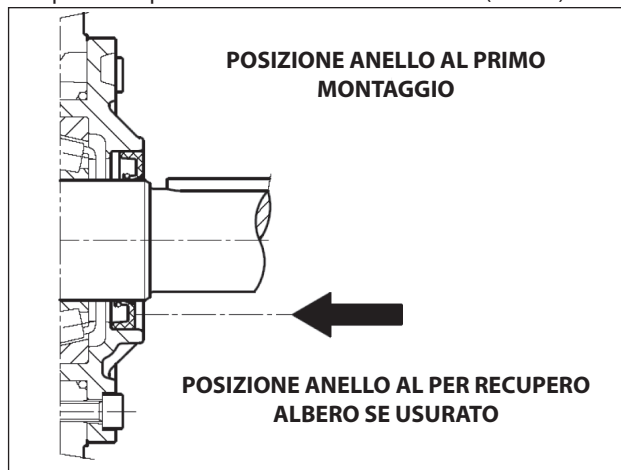

Fig. 7

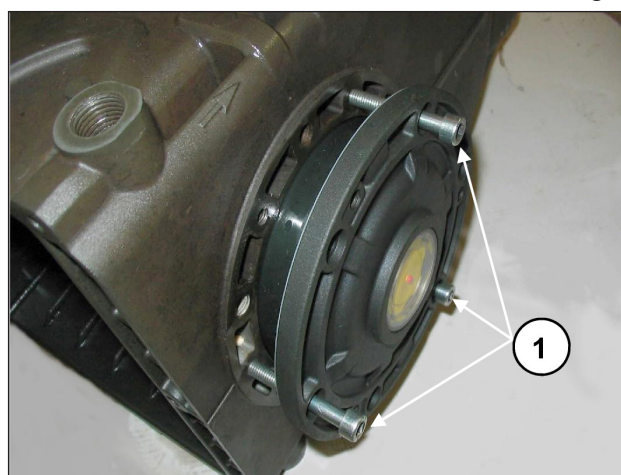

Fig. 8



- Accoppiare i cappelli biella ai relativi fusti facendo riferimento alla numerazione (Fig. 9, pos. ①).

Prestare attenzione al corretto senso di montaggio dei cappelli.

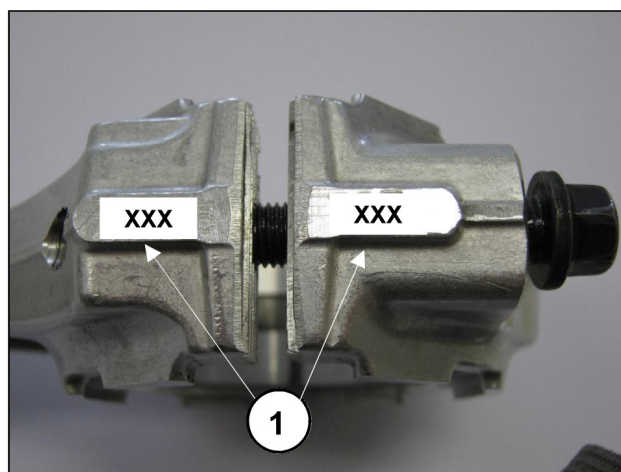

Fig. 9

- Fissare i cappelli ai rispettivi fusti biella mediante le viti M8x1x48 (Fig. 10) lubrificando sia il sottotesta che il gambo filettato, procedendo in due differenti fasi:



1. **Eseguire manualmente l'avvitamento delle viti fino ad inizio serraggio**
 2. **Coppia di serraggio** **30 Nm**
- In alternativa eseguire:
1. **Coppia di pre-serraggio** **10-15 Nm**
 2. **Coppia serraggio** **30 Nm**



Fig. 10

- Dopo avere completato l'operazione di serraggio, verificare che la testa di biella abbia un gioco laterale nei due sensi.
- Montare i nuovi anelli di tenuta delle guide pistone fino a battuta con la relativa sede sul carter pompa (Fig. 11) seguendo la procedura descritta: utilizzare l'attrezzo cod. 27904900 composto da bussola conica e tampone. Avvitare la bussola conica nel foro presente sulla guida pistone (Fig. 11/a), inserire il nuovo anello di tenuta sul tampone e portarlo a battuta (determinata dall'altezza del tampone stesso) nella propria sede sul carter pompa (Fig. 11/b), togliere la bussola conica (Fig. 11/c).

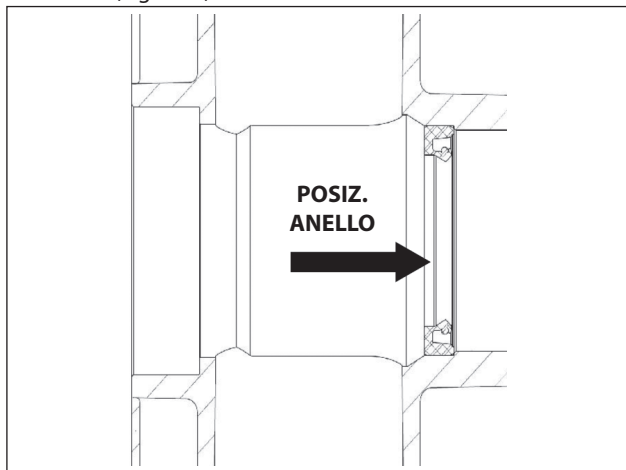

Fig. 11

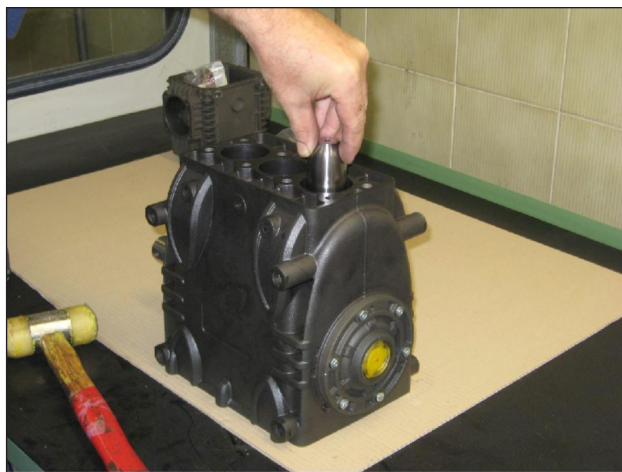

Fig. 11/a



Fig. 11/b



Fig. 11/c

- Montare il coperchio posteriore completo dell'O-ring di tenuta, posizionando il foro dell'asta livello olio verso l'alto.
- Inserire l'olio nel carter come indicato nel **Manuale uso e manutenzione**.

2.1.3 Classi di minorazioni previste

TABELLA MINORAZIONI PER ALBERO A GOMITI E SEMICUSCINETTI DI BIELLA			
Classi di recupero (mm)	Codice Semicuscinetto Superiore	Codice Semicuscinetto Inferiore	Rettificata sul diametro perno dell'albero (mm)
0.25	90924100	90924400	Ø49.75 0/-0.02 Ra 0.4 Rt 3.5
0.50	90924200	90824500	Ø49.50 0/-0.02 Ra 0.4 Rt 3.5

2.1.4 Smontaggio / rimontaggio cuscinetti e rasamenti

La tipologia dei cuscinetti (a rulli conici), garantisce l'assenza del gioco assiale dell'albero a gomito; i rasamenti vanno definiti per raggiungere tale scopo. Per lo smontaggio / rimontaggio e per l'eventuale sostituzione si devono seguire attentamente le indicazioni seguenti:

A) Smontaggio / Rimontaggio albero a gomito senza sostituzione dei cuscinetti

Dopo aver smontato i coperchi laterali, come indicato al par. 2.1.1, controllare lo stato dei rulli e delle relative piste; se tutte le parti saranno ritenute idonee, pulire accuratamente i componenti con apposito sgrassante e ridistribuire in modo uniforme olio lubrificante.

Possono essere riutilizzati gli spessori precedenti facendo attenzione a inserirli solo sotto il coperchio lato spia.

Montato il gruppo completo (Flangia lato spia + albero + flangia lato motore) e serrate le viti dei coperchi alla coppia prescritta, verificare che la coppia di rotolamento dell'albero a bielle non collegate rientri in un valore compreso tra 4 e 6 Nm. Per l'avvicinamento dei due coperchi laterali al carter si possono utilizzare N°3 viti M6x40 per una prima fase di orientamento, come indicato in precedenza, e le viti previste per il fissaggio finale.

La coppia di rotolamento dell'albero con bielle collegate non dovrà superare il valore di 8 Nm.

B) Smontaggio / Rimontaggio albero a gomito con sostituzione dei cuscinetti

Dopo aver smontato i coperchi laterali, come indicato in precedenza, togliere la ghiera esterna dei cuscinetti dai relativi alloggiamenti sui coperchi utilizzando un'estrattore appropriato come indicato nelle Fig. 12 e Fig. 12/a.

Togliere la ghiera interna dei cuscinetti dalle due estremità dell'albero sempre utilizzando un'estrattore appropriato o, in alternativa, un semplice "cacciaspine" come indicato in Fig. 13.



Fig. 12

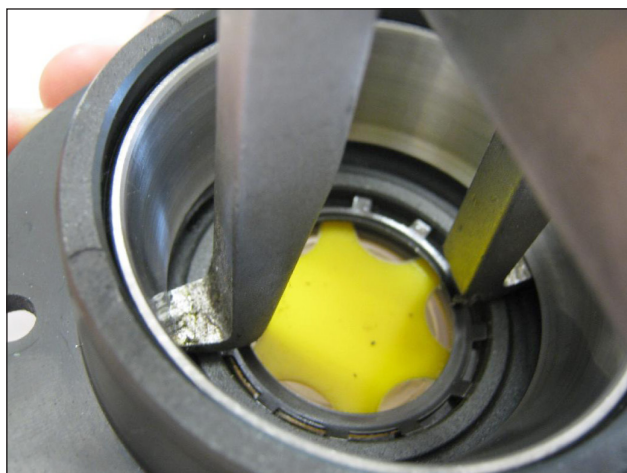

Fig. 12/a



Fig. 13

I nuovi cuscinetti possono essere montati a freddo con pressa o bilanciere, appoggiandoli necessariamente sulla superficie laterale delle ghiera interessate al piantaggio con appositi anelli. L'operazione di piantaggio potrebbe essere facilitata scaldando le parti interessate ad una temperatura compresa tra 120° - 150°C (250° - 300°F), assicurandosi che le ghiera vadano a battuta nelle rispettive sedi.



Non scambiare mai le parti dei due cuscinetti.

Determinazione del pacco dei rasamenti:

Eeguire l'operazione con gruppi guida pistone-bielle montati, cappelli biella scollegati e bielle spinte in basso. Inserire l'albero pompa privo di linguetta nel carter, assicurandosi che il codolo P.T.O fuoriesca dal fianco previsto.

Fissare la flangia lato P.T.O al carter, ponendo la massima attenzione al labbro dell'anello di tenuta, secondo la procedura descritta in precedenza e serrare le viti di fissaggio alla coppia prevista.

Successivamente imboccare la flangia lato spia senza spessori nel carter ed iniziare ad avvicinarla avvitando manualmente le viti di servizio M6x40 in modo equo, con piccole rotazioni tali da generare un'avanzamento lento e corretto del coperchio.

Contemporaneamente verificare, ruotandolo manualmente, che l'albero giri liberamente.

Continuando la procedura con questa modalità si arriverà ad avvertire un'improvviso aumento di durezza nella rotazione dell'albero.

A quel punto interrompere l'avanzamento del coperchio ed allentare completamente le viti di fissaggio.

Con l'ausilio di uno spessimetro rilevare il gioco tra coperchio laterale e carter pompa (vedere Fig. 14).



Fig. 14

Procedere a determinare il pacco degli spessori utilizzando la tabella sottostante:

Misura Rilevata	Tipo Spessore	N° pezzi
Da: 0,05 a: 0,10	/	/
Da: 0,11 a: 0,20	0,1	1
Da: 0,21 a: 0,30	0,1	2
Da: 0,31 a: 0,35	0,25	1
Da: 0,36 a: 0,45	0,35	1
Da: 0,46 a: 0,55	0,35 0,10	1 1
Da: 0,56 a: 0,60	0,25	2
Da: 0,61 a: 0,70	0,35 0,25	1 1



Fig. 15

Determinato dalla tabella tipo e numero di spessori effettuare il seguente controllo: montare il pacco di spessori sul centraggio coperchio lato spia (Fig. 15), fissare il coperchio al carter seguendo la procedura del par. 2.1.2, serrare le rispettive viti alla coppia prevista.

Verificare che la coppia resistente di rotazione dell'albero rientri in un valore compreso tra 4 Nm e 6 Nm.

Se tale coppia risulta corretta procedere con il collegamento delle bielle all'albero a gomiti ed alle fasi successive, diversamente ridefinire il pacco spessori ripetendo le operazioni.

2.2 RIPARAZIONE DELLA PARTE IDRAULICA

2.2.1 Smontaggio testata-gruppi valvole

La testata non necessita di manutenzione periodica.

Gli interventi sono limitati all'ispezione o sostituzione delle valvole, qualora necessario.

Per l'estrazione dei gruppi valvola operare come segue:

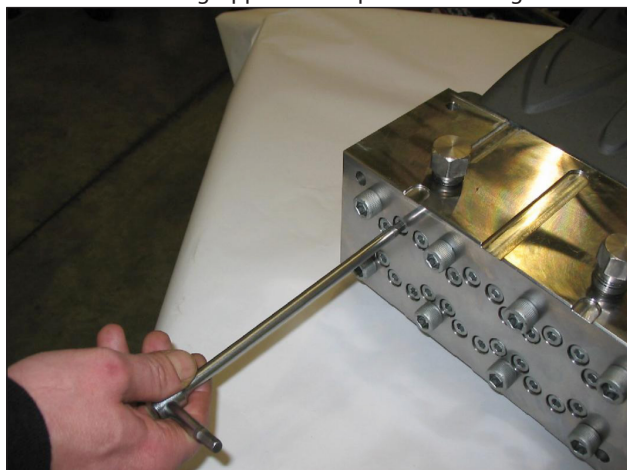

Fig. 16



- Allentare senza rimuovere le viti M8x100 fissaggio camicie alla testata, come indicato in Fig. 16, in modo tale da renderle libere.

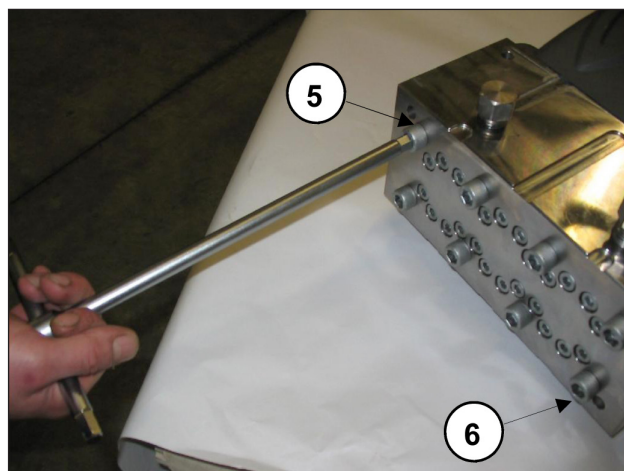

Fig. 17

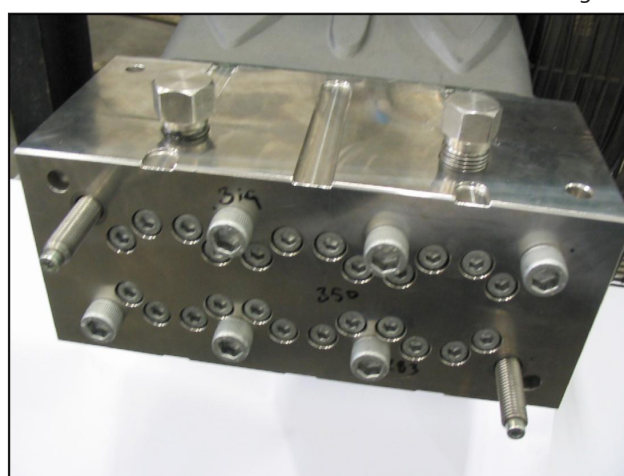

Fig. 18

- Svitare le viti fissaggio testata M12x260 N° 5 e N° 6 come indicato in Fig. 17 sostituendole con due viti -spina di servizio (cod. 27508200) come indicato in Fig. 18. Quindi procedere alla rimozione delle restanti viti.



Fig. 19

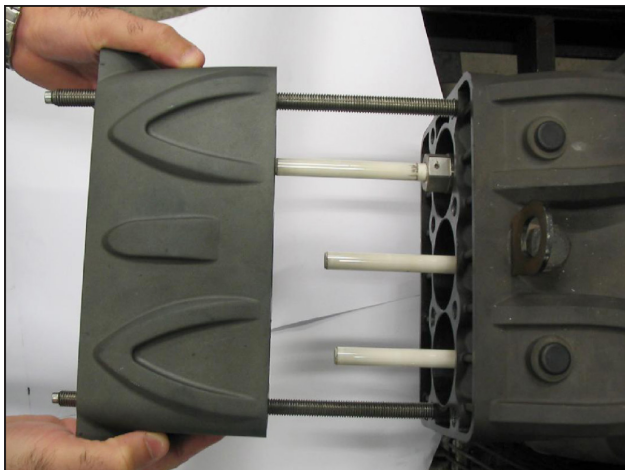

Fig. 20

- Separare la testata e il distanziale per camicie dal carter pompa come indicato nelle Fig. 19 e Fig. 20.



Fig. 21

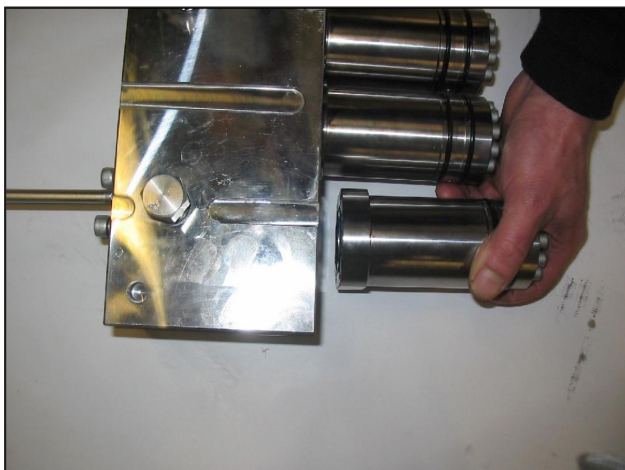

Fig. 22

- Rimuovere le viti M8x100 fissaggio camicie a testata come indicato in Fig. 21 e procedere come indicato in Fig. 22.

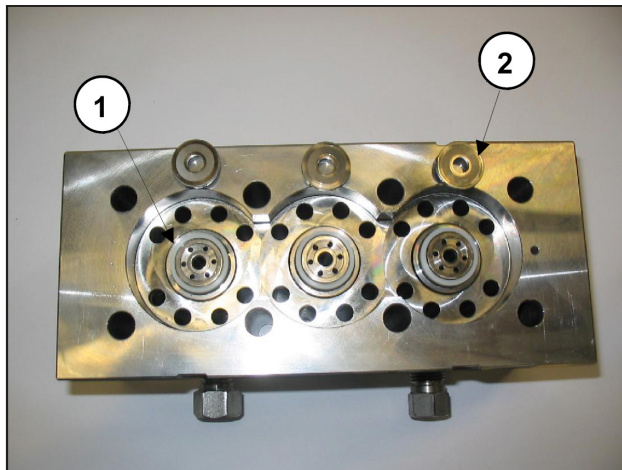

Fig. 23



Durante lo smontaggio delle camicie fare attenzione a non disperdere le sedi valvola ① e le valvole piane ② come indicato in Fig. 23 le quali essendo posizionate solo a battuta potrebbero cadere.

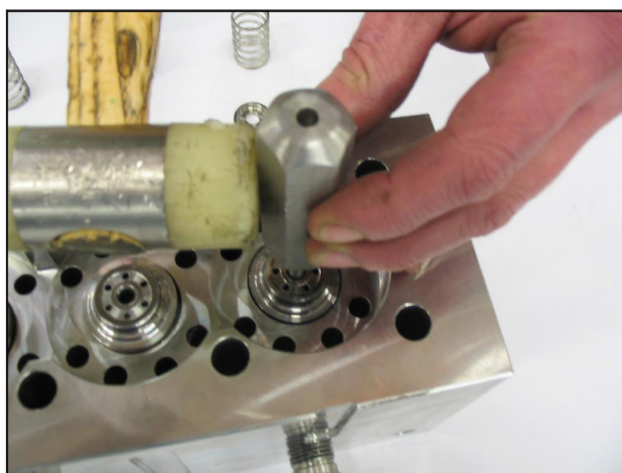

Fig. 24



Qualora le sedi valvola risultassero bloccate sulla testata causa formazione di calcare o di ossido devono essere sbloccate inserendo l'apposito attrezzo (cod. 27508000 "VF12" - "VF14") nel foro di aspirazione operando come in Fig. 24.

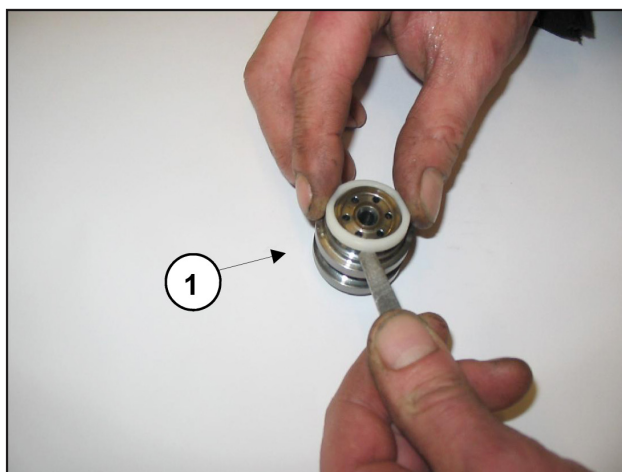

Fig. 25

- Estrarre le sedi valvola ① come indicato in Fig. 25, controllare lo stato di usura dei vari componenti e se necessario eseguire eventuali sostituzioni.



Ad ogni ispezione delle valvole sostituire sempre tutti gli anelli di tenuta e i relativi O-ring di tenuta frontale tra camicia e testata, tra testata e distanziale camicie zona foro di ricircolo.

Prima del rimontaggio pulire ed asciugare i vari componenti e tutti i relativi alloggiamenti all'interno della testata.

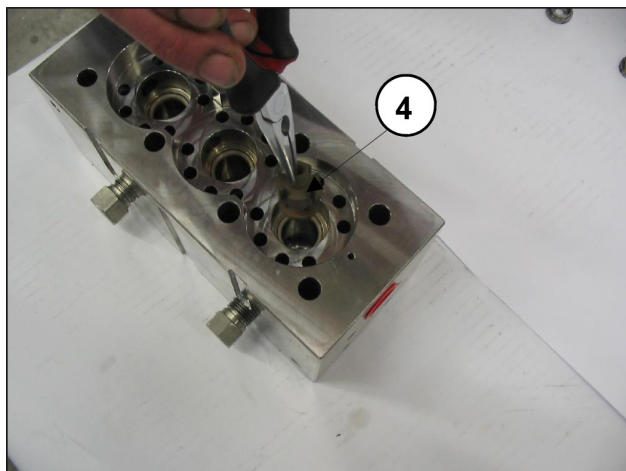

Fig. 26

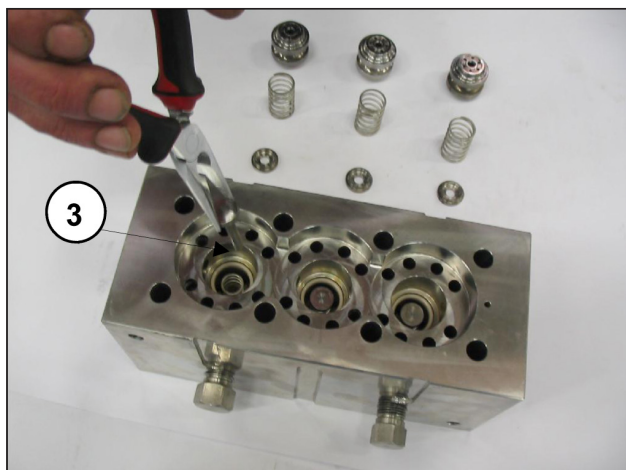

Fig. 27

- Estrarre i piattelli di mandata ③ e le rispettive guide ④ con relative molle, come indicato in Fig. 26 e Fig. 27, controllare il loro stato di usura ed eseguire se necessario eventuali sostituzioni, e comunque negli intervalli indicati nella tabella "MANUTENZIONE PREVENTIVA" di capitolo 11 del **Manuale uso e manutenzione**.

2.2.2 Rimontaggio della testata - camicie - valvole



Per rimontare i vari componenti invertire le operazioni precedentemente elencate facendo particolare attenzione al montaggio corretto del distanziale per camicie: i due scarichi grezzi di fusione presenti su uno dei due fianchi a particolare montato devono risultare orientati verso la parte inferiore del carter (lato staffaggio pompa).

Testate - camicie: procedere al montaggio e alla taratura delle viti fissaggio testata e poi procedere alla taratura delle viti fissaggio camicie.

Per i valori delle coppie di serraggio e le varie fasi rispettare le indicazioni riportate nel capitolo 3.

2.2.3 Smontaggio del gruppo pistone - supporti - tenute

Il gruppo pistone non necessita di manutenzione periodica. Gli interventi sono limitati al solo controllo visivo del drenaggio del circuito di raffreddamento. Qualora si presentassero anomalie / oscillazioni sul manometro di mandata o pulsazioni del tubo di drenaggio del circuito di raffreddamento (se elastico), sarà necessario procedere al controllo e alla eventuale sostituzione del pacco tenute. Per l'estrazione dei gruppi pistone operare come segue.

- Separare la testata e il distanziale per camicie dal carter pompa come indicato nel par. 2.2.1 (Fig. 19, Fig. 20).

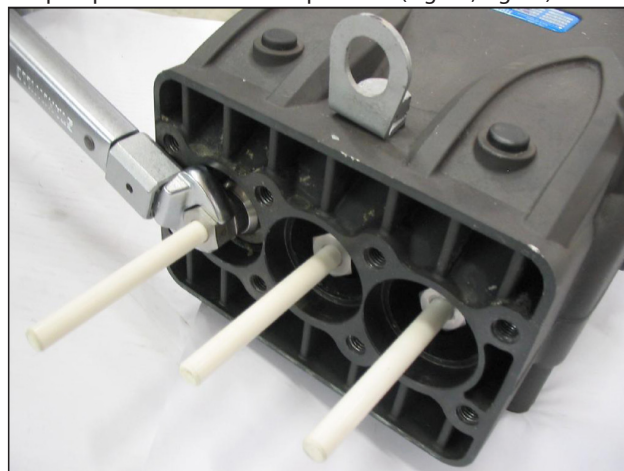

Fig. 28

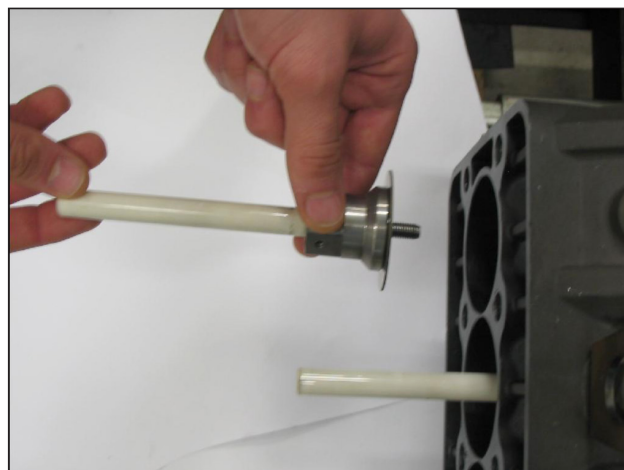

Fig. 29

- Rimuovere i pompanti con una chiave a forchetta e controllare il loro stato di usura come indicato in Fig. 28 e Fig. 29, sostituirli se necessario.
- Rimuovere le viti M6x40 fissaggio supporto a camicia come indicato in Fig. 30 e procedere alla separazione del supporto come indicato in Fig. 31.



Fig. 30

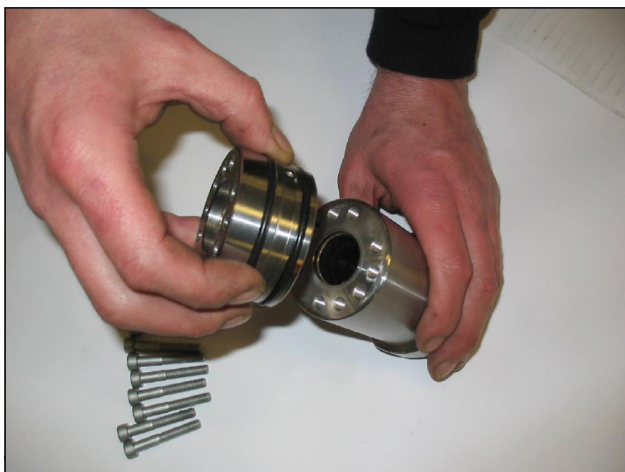

Fig. 31

- Rimuovere l'anello seeger e l'anello di ritegno tenute come indicato in Fig. 32, e con una apposita spina in materiale plastico estrarre la guarnizione di tenuta LP (bassa pressione) ① come indicato in Fig. 33.



Fig. 32

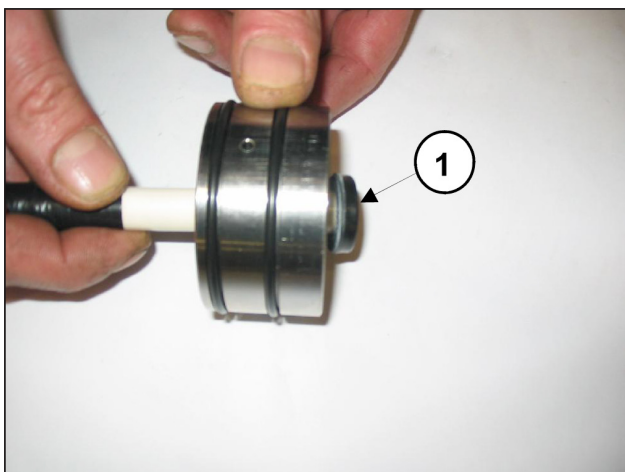

Fig. 33



Ad ogni smontaggio le tenute di bassa pressione dovranno essere sostituite come anche tutti gli O-ring.

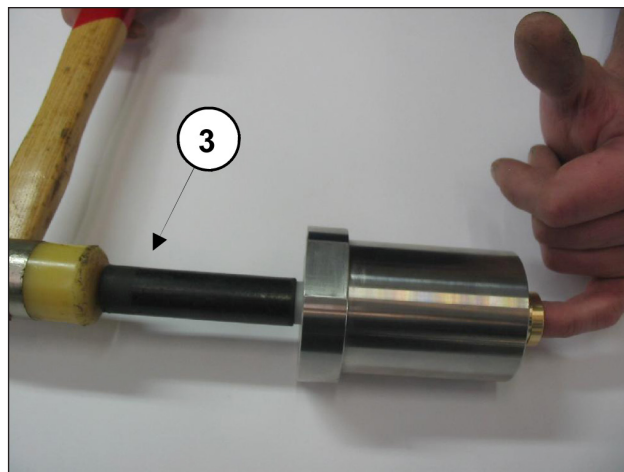

Fig. 34

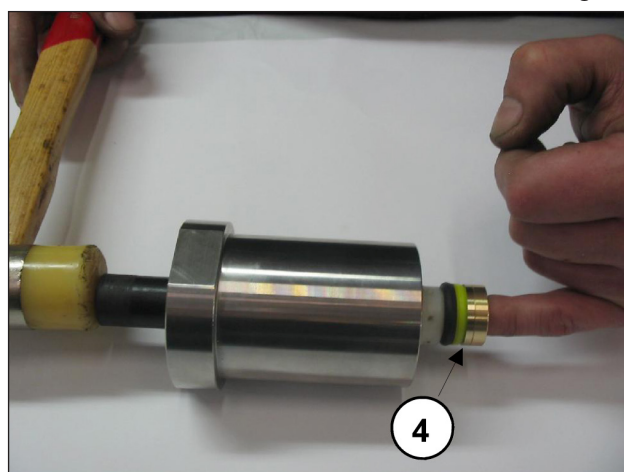

Fig. 35

- Con la camicia separata dal supporto tenute e con una apposita spina in materiale plastico ③ come indicato in Fig. 34 fare fuoriuscire il pacco HP (alta pressione) ④ operando come in Fig. 35.



Ad ogni smontaggio il pacco HP (Fig. 31, pos. ④) dovrà essere sostituito.

2.2.4 Rimontaggio del gruppo pistone - supporti - tenute

Per il rimontaggio dei vari componenti invertire le operazioni descritte in precedenza, facendo particolare attenzione alle varie sequenze sotto elencate; per i valori delle coppie di serraggio e le varie fasi, rispettare le indicazioni riportate nel capitolo 3.

- Inserire la bussola superiore nella camicia.



Fig. 36



Fig. 37



Per un corretto posizionamento assiale della bussola utilizzare l'apposito attrezzo (cod. 27508300 valido per pompe tipo VF12 e cod. 27508500 valido per pompe tipo VF14) come indicato in Fig. 36 e Fig. 37.



Fig. 38

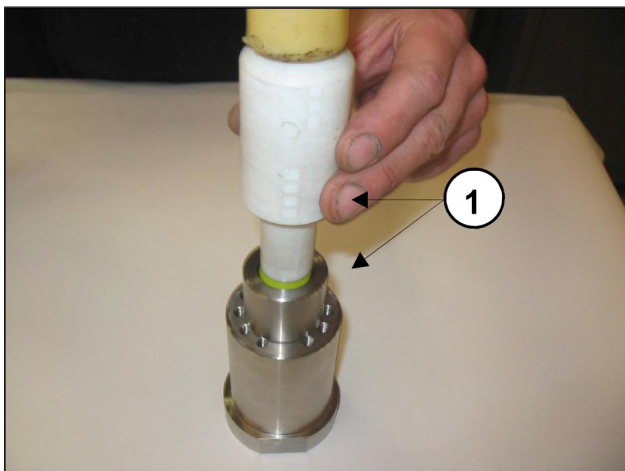

Fig. 39

- Introdurre il pacco H.P. (alta pressione); data la leggera interferenza tra la tenuta e la camicia per evitare eventuali danneggiamenti si consiglia l'utilizzo dell'attrezzo indicato in Fig. 38 e Fig. 39 pos. ① (cod. 27508400 e cod. 27365300).

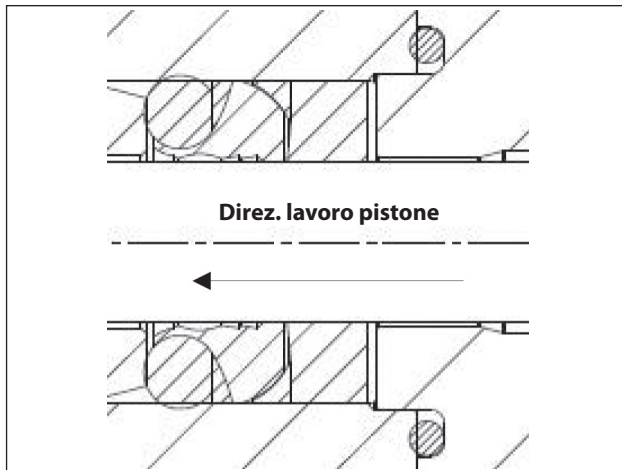

Fig. 40

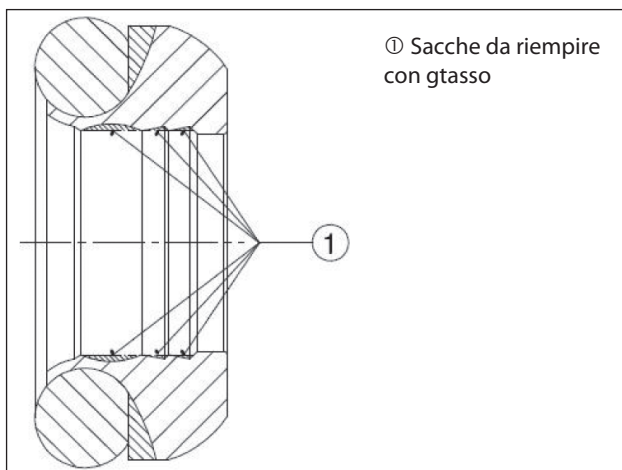

Fig. 40/a



La tenuta H.P. deve essere introdotta nella camicia con l'O-ring energizzante di tenuta nella direzione di lavoro del pistone come indicato in Fig. 38 e Fig. 40.



Prima del montaggio in sede le tenute di H.P. devono essere lubrificate con grasso al silicone tipo OK S1110 attenendosi alle operazioni sotto indicate:

- Il diametro esterno deve risultare solo leggermente lubrificato;
- Sul diametro interno il grasso deve essere applicato prestando particolare cura al riempimento di tutte le sacche comprese tra i labbri di tenuta come indicato in Fig. 40/a.

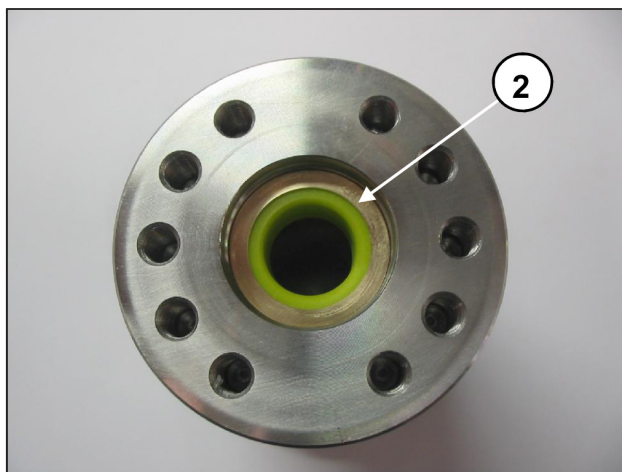

Fig. 41

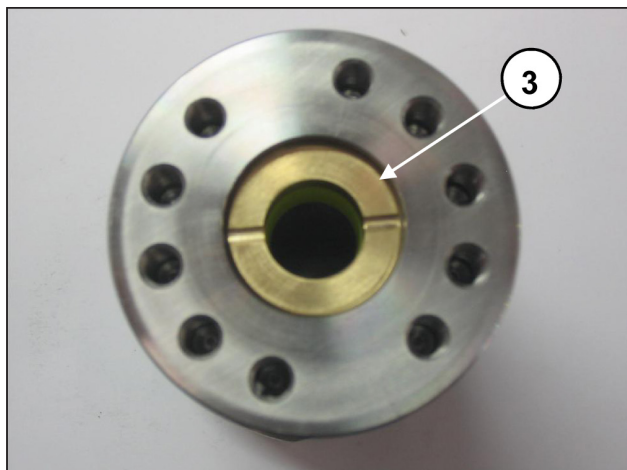

Fig. 42



Fig. 45

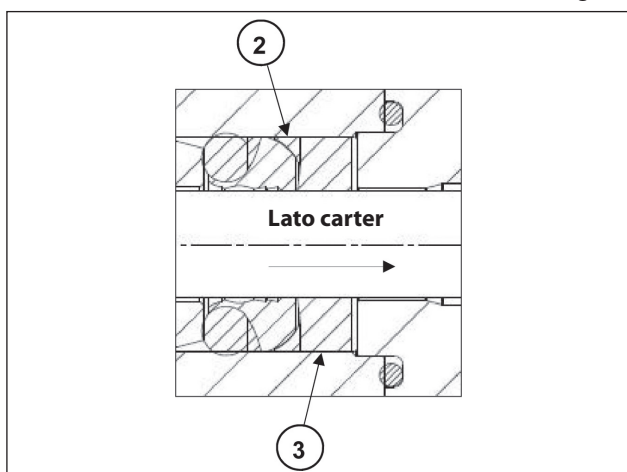

Fig. 43

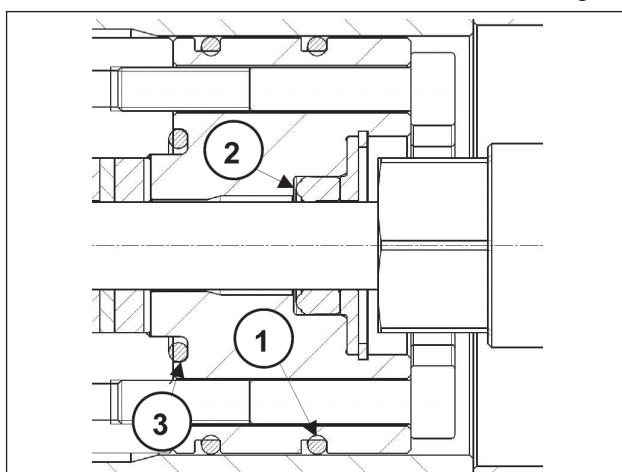

Fig. 46

- Introdurre l'anello antiestrusore ② e la bussola guarnizioni ③ posizionati come da Fig. 41, Fig. 42, Fig. 43.



La bussola guarnizioni ③ deve essere introdotta nella camicia con gli scarichi rivolti verso l'esterno (lato carter) come indicato in Fig. 42 e in Fig. 43.



La tenuta L.P. deve essere introdotta nella camicia con il labbro di tenuta nella direzione di lavoro del pistone come indicato in Fig. 44 e Fig. 45, lubrificando leggermente il diametro esterno con grasso al silicone tipo OKS 1110.

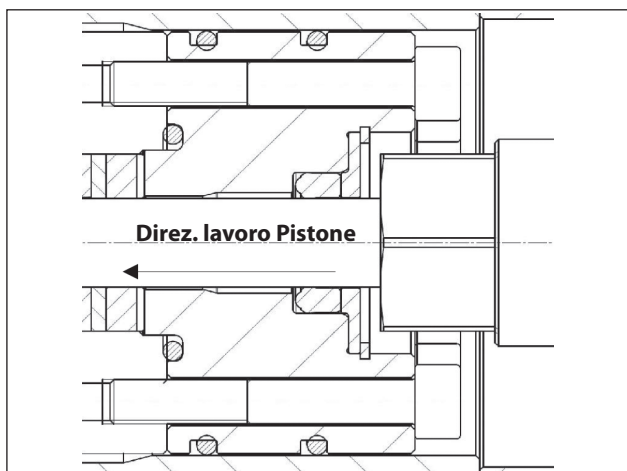

Fig. 44

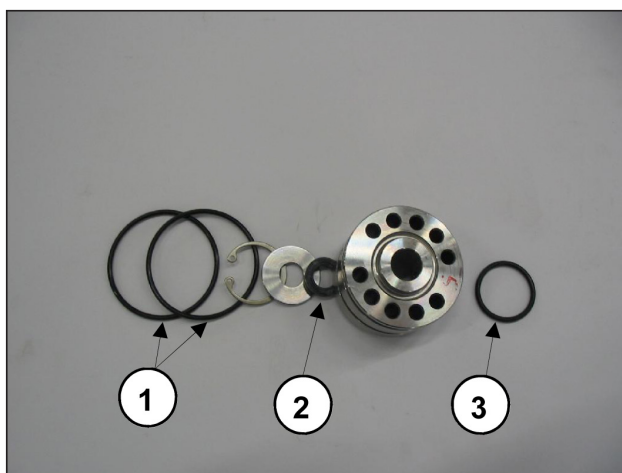

Fig. 47

- Rimontare il gruppo supporto tenute come indicato in Fig. 46 e Fig. 47 sostituendo i componenti ①②③.



Fig. 48

- Assemblare il gruppo supporto - camicia avvitando manualmente le viti M6x40 come indicato in Fig. 48. Successivamente procedere alla taratura con chiave dinamometrica come indicato nel capitolo 3.

3 TARATURE SERRAGGIO VITI

Il serraggio delle viti è da eseguirsi esclusivamente con chiave dinamometrica.

Descrizione	Posiz. esploso	Coppia di serraggio Nm
Vite Fissaggio Coperchi	9	10
Tappo scarico olio	11	40
Vite Fissaggio staffa sollev.	17	40
Vite Fissaggio Capp. biella	16	30*
Fissaggio Pistoni	28	20
Raccordo Strozzatore	31	10
Vite Fissaggio supporti	44	15****
Vite Fissaggio Testata	57	80**
Vite Fissaggio camicia	56	35***
Vite Flangia Mot.Idrraulico	64	40

* Le viti fissaggio cappello di biella devono essere serrate rispettando le fasi indicate a pag. 6.

** Le viti fissaggio testata devono essere serrate rispettando le fasi e l'ordine riportato nello schema di Fig. 50.

*** Le viti fissaggio camicia devono essere serrate rispettando le fasi e l'ordine riportato nello schema di Fig. 50.

**** Le viti fissaggio supporti devono essere serrate in un'unica fase rispettando l'ordine riportato nello schema di Fig. 49.

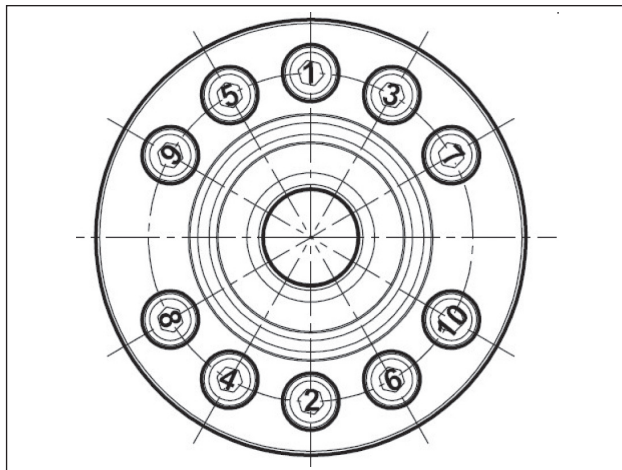

Fig. 49



Le viti - pos. 44-57 - devono essere serrate con chiave dinamometrica lubrificando il gambo filettato.

Serraggio viti testata e camicie

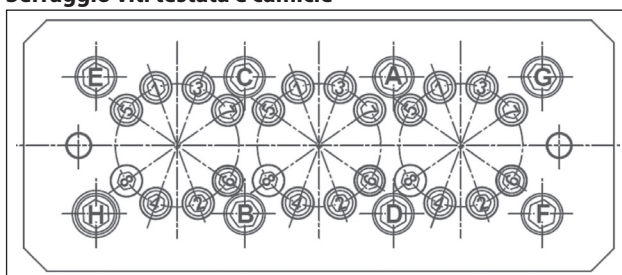

Fig. 50

OPERAZIONE 1: Serraggio viti M12x260 (pos. 56) in due fasi rispettando la sequenza indicata in figura: (A-B-C-D-E-F-G-H)

Fase 1 = 40 Nm

Fase 2 = 80 Nm

OPERAZIONE 2: Serraggio viti M8x100 (pos. 57) in quattro fasi rispettando la sequenza indicata in figura: (1-2-3-4-5-6-7-8)

Fase 1 = 20 Nm

Fase 2 = 30 Nm

Fase 3 = 35 Nm

Fase 4 = 35 Nm

4 SOSTITUZIONE BOCCOLA PIEDE BIELLA

In fase di manutenzione se si rende necessario sostituire la boccola piede biella attenersi alle seguenti indicazioni:



Nel rimuovere la boccola usurata fare estrema attenzione a non danneggiare o rigare l'alloggiamento sulla biella.

Eseguire il piantaggio a freddo della nuova boccola, durante tale operazione assicurarsi che:

- il foro di lubrificazione coincida con il corrispondente foro presente sulla biella;
- il taglio di giunzione venga orientato come indicato in Fig. 51.



Eseguire successivamente le lavorazioni meccaniche rispettando tassativamente dimensioni e tolleranze riportate in Fig. 51.

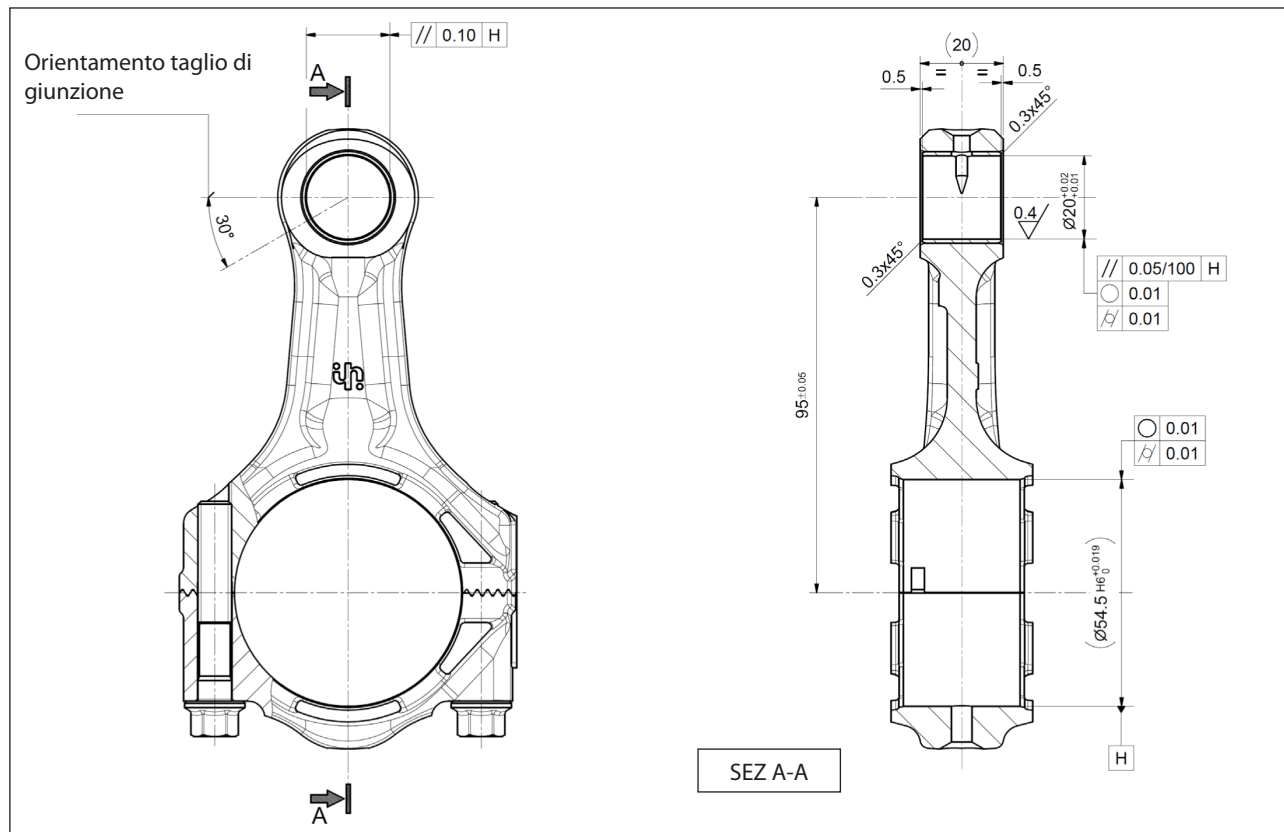

Fig. 51

5 ATTREZZI PER LA RIPARAZIONE

La riparazione della pompa può essere facilitata tramite appositi attrezzi a seguito codificati:

Per le fasi di montaggio:

Bussola guarnizioni VF12; Anello tenuta alternativa di H.P. Ø 12x24x13	cod. 27508400
	cod. 27365300
Bussola guarnizioni VF14; Anello tenuta alternativa di H.P. Ø 14x24x13	cod. 27508400
	cod. 27365300
Colonna di montaggio testata (N°2 pezzi)	cod. 27508200
Bussola per pistone Ø12	cod. 27508300
Bussola per pistone Ø14	cod. 27508500
Tampone per paraolio albero pompa	cod. 27904800
Tampone per paraolio guida pistone	cod. 27904900

Per le fasi di smontaggio:

Sedi valvola VF12 - VF14	cod. 27508000
Colonna di montaggio testata (N°2 pezzi)	cod. 27508200
Paraolio guida pistone	cod. 27503900
	cod. 26019400

Table of Contents

1	INTRODUCTION	17
1.1	DESCRIPTION OF SYMBOLS.....	17
2	REPAIR GUIDELINES	17
2.1	REPAIRING MECHANICAL PARTS.....	17
2.1.1	<i>Disassembly of mechanical parts</i>	17
2.1.2	<i>Reassembly of mechanical parts</i>	19
2.1.3	<i>Reduction classes</i>	20
2.1.4	<i>Disassembly / Reassembly of bearings and shims</i>	21
2.2	REPAIRING HYDRAULIC PARTS.....	22
2.2.1	<i>Dismantling the head-valve units</i>	22
2.2.2	<i>Reassembling the head - liners - valves</i>	24
2.2.3	<i>Disassembly of the piston unit – supports – seals</i>	24
2.2.4	<i>Reassembly of the piston unit – supports – seals</i>	26
3	SCREW TIGHTENING CALIBRATION	28
4	REPLACING THE CON-ROD FOOT BUSH	29
5	REPAIR TOOLS	29

1 INTRODUCTION

This manual describes the instructions for repairing VF series pumps and should be carefully read and understood before any intervention on the pump.

Proper pump operation and duration depend on the correct use and maintenance.

Interpump Group disclaims any responsibility for damage caused by negligence or failure to observe the standards described in this manual.

1.1 DESCRIPTION OF SYMBOLS

Read the contents of this manual carefully before each operation.



Warning Sign



Read the contents of this manual carefully before each operation.



Danger Sign

Wear protective goggles.



Danger Sign

Put on protective gloves before each operation.

2 REPAIR GUIDELINES



2.1 REPAIRING MECHANICAL PARTS

Mechanical parts must be repaired after the oil has been removed from the casing.

To remove oil, you must remove: the oil dipstick, pos. ① and then the plug pos. ②, Fig. 1.

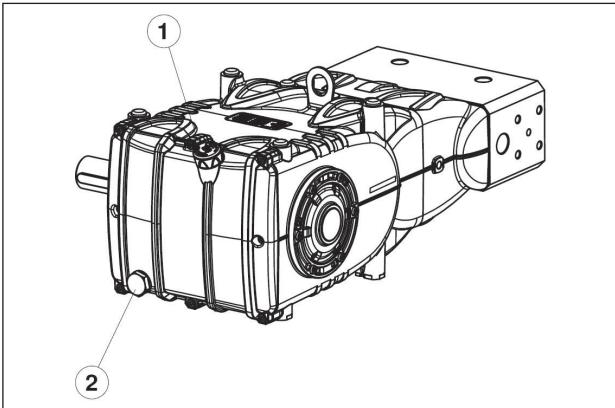

Fig. 1



The used oil must be placed in a suitable container and disposed of in special centres. It absolutely should not be discarded into the environment.

2.1.1 Disassembly of mechanical parts

The operations described must be performed after removing the hydraulic part, ceramic pistons and splash guards from the pump (par. 2.2.3, 2.2.4).

Remove in the following order:

- the pump shaft tab
- the rear cover
- the con-rod cap as follows: unscrew the cap fixing screws, remove the con-rod caps with their lower half-bearings (Fig. 2) paying attention to the numbered sequence during disassembly.

To avoid possible errors, caps and con-rod shanks have been numbered on one side (Fig. 2/a, pos. ①).

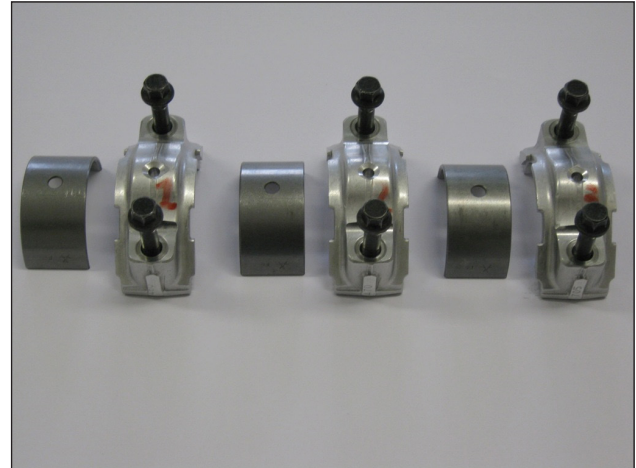

Fig. 2

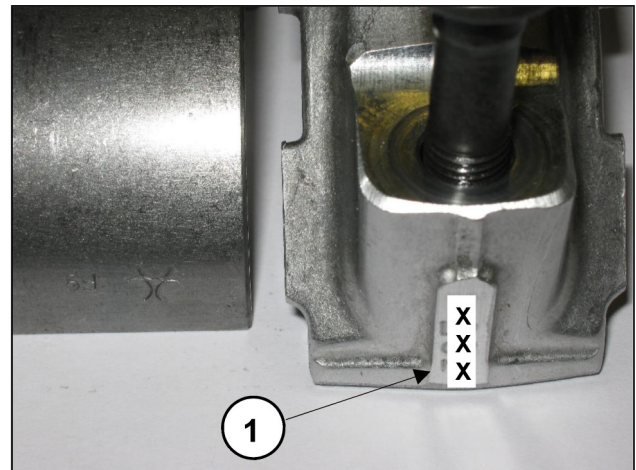

Fig. 2/a

- the side covers using - for extraction 3 fully threaded M6x50 screws, inserting them in the threaded holes as indicated in Fig. 3.

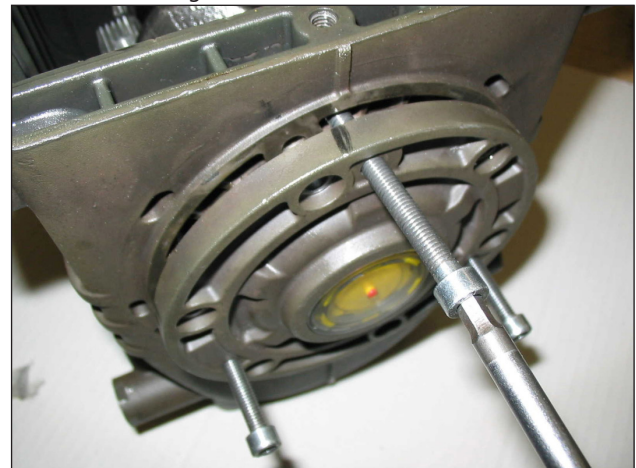

Fig. 3

- Push the piston guides forward with their con-rods to facilitate side extraction of the pump shaft. There are two reference points visible on the shaft (indicated with 1 in Fig. 4 and in Fig. 4/a). These must be turned toward the operator to facilitate extraction.

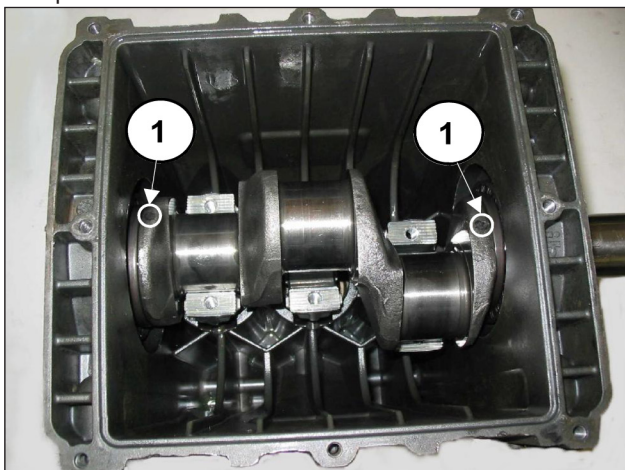

Fig. 4

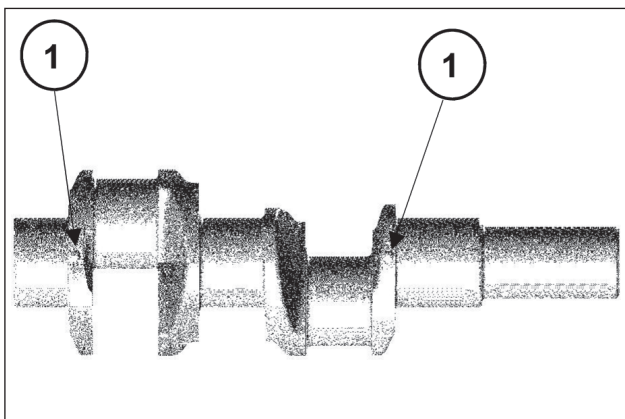

Fig. 4/a

- Remove the pump shaft
- Complete disassembly of the con-rod units by removing them from the pump casing and removing the piston guide pins.
- Remove the pump shaft seal rings using common tools.
- Remove the piston guide seal rings as described below: use the extractor code 26019400 (Fig. 5, pos. ①) and the pliers code 27503900 (Fig. 5, pos. ②). Insert the gripper as far as possible onto the seal ring with the aid of a hammer (Fig. 5/a), subsequently screwing the extractor to the gripper, and use the extractor hammer (Fig. 5/b) until the ring to be replaced is removed (Fig. 5/c).



Fig. 5/a



Fig. 5/b



Fig. 5/c

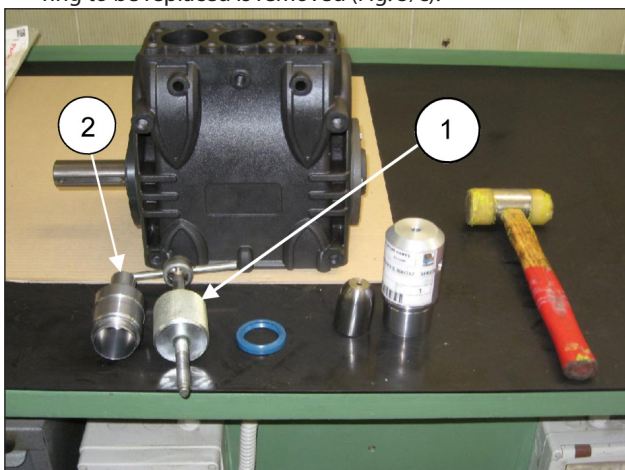

Fig. 5

2.1.2 Reassembly of mechanical parts

After having checked that the casing is clean, proceed with assembly of the mechanical part as described below:

- Assemble the upper and lower half-bearings in their seats in the con-rods and caps.



Make sure that the reference marks on the upper half-bearings (Fig. 6, pos. ①) and lower half-bearing (Fig. 6/a, pos. ②) are positioned in their respective seats in the con-rod and cap.

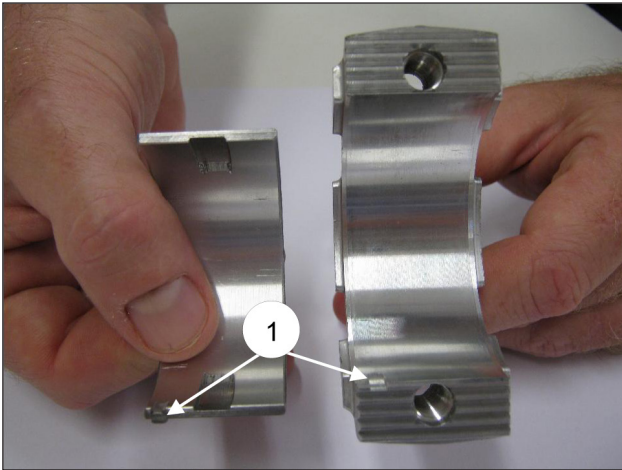

Fig. 6

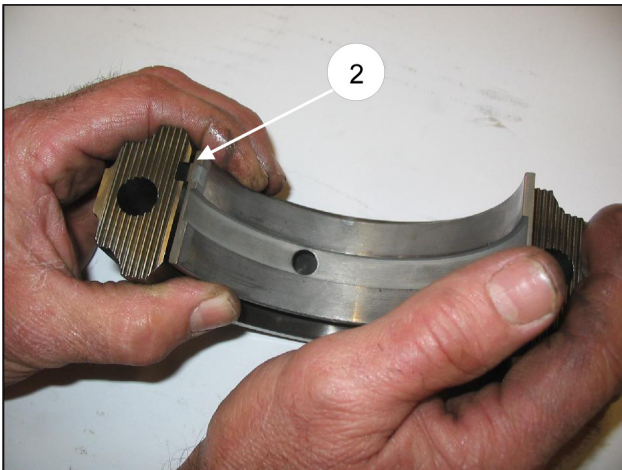

Fig. 6/a

- Insert the piston/con-rod guide units into the pump casing, directing the numbering on the con-rod shank towards the top of the casing.

To facilitate pump shaft insertion (without the tab), it is essential to repeat the operation performed during disassembly, pushing the piston/con-rod guide units as far down as possible (par. 2.1.1).

- Before assembling the side cover on the PTO side, check the conditions of the radial ring lip seal and relative contact area on the shaft.

If replacement is necessary, position the new ring using a tool (code 27904800) as shown in Fig. 7.



If the pump shaft shows diametrical wear in the area of contact with the lip seal, in order to prevent the grinding operation, it is possible to reposition the ring in abutment with the cover as shown in Fig. 7.

Before assembling the side covers, make sure there are O-rings on both of them and shim rings on the indicator side cover only.

To facilitate filling of the first section and relative press fitting of the covers on the casing, we recommend using 3 partially-threaded M6 x 40 screws (Fig. 8, pos. ①), then completing the operation with the screws supplied (M6x18).

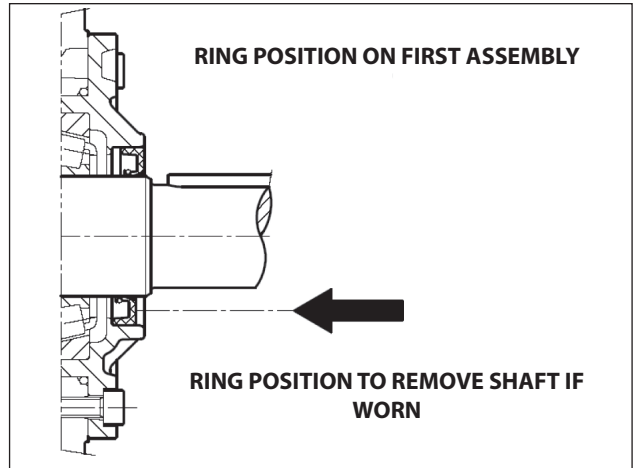

Fig. 7

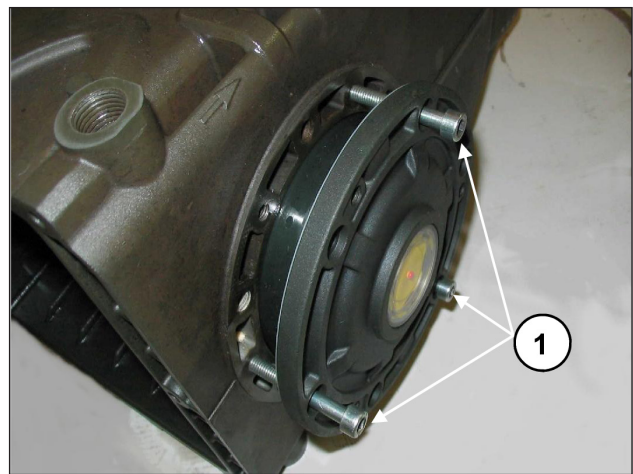

Fig. 8



- Couple the con-rod caps to their shanks, referring to the numbering (Fig. 9, pos. ①). **Note the correct assembly direction of the caps.**

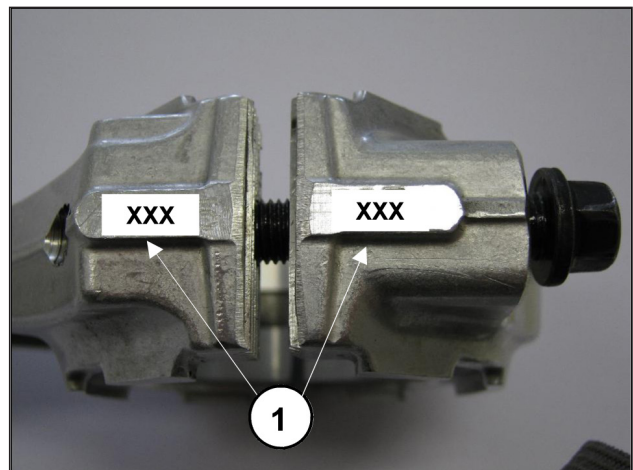

Fig. 9

- Fasten the caps to their respective con-rod shanks by means of M8x1x48 screws (Fig. 10) lubricating both the underhead and the threaded shank, proceeding in two different stages:



1. **Manually turn the screws until they begin to tighten**
 2. **Tightening torque** **30 Nm**
- Alternatively, ensure:**
1. **Pre-tightening torque** **10-15 Nm**
 2. **Tightening torque** **30 Nm**

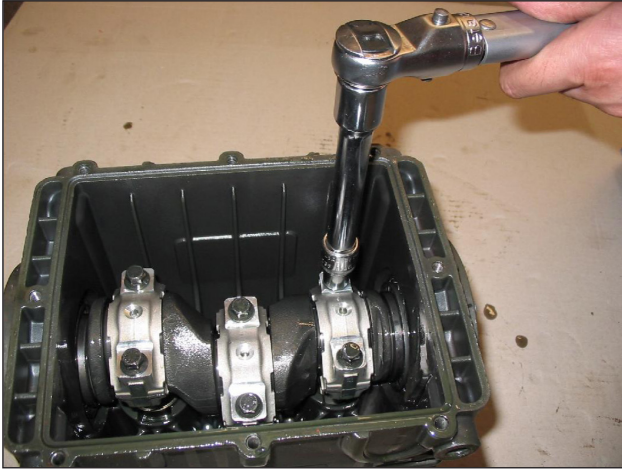

Fig. 10

- After having completed tightening operations, check that the con-rod head has a side clearance in both directions.
- Insert the new piston guide seal rings as far as possible into the relative seat on the pump casing (Fig. 11), following the procedure described: use the tool code 27904900 composed of a tapered bush and a buffer. Screw the tapered bush into the hole in the piston guide (Fig. 11/a), insert the new seal ring on the buffer as far as it will go (determined by the height of the buffer) into its seat on the pump casing (Fig. 11/b), remove the tapered bush (Fig. 11/c).

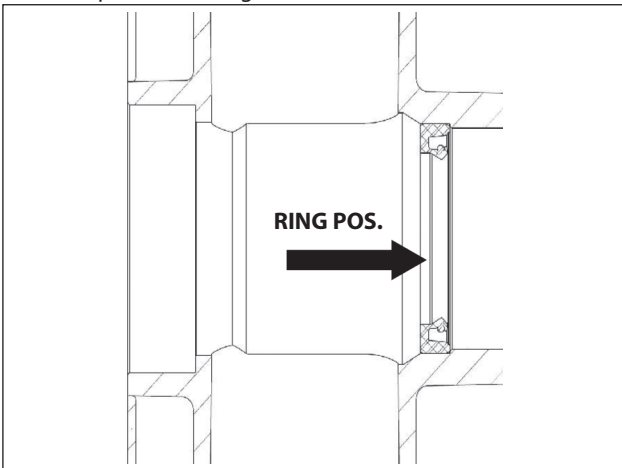

Fig. 11



Fig. 11/a



Fig. 11/b



Fig. 11/c

- Mount the rear cover complete with the O-ring, positioning the dipstick hole upward.
- Insert oil in the casing as indicated in the **Use and maintenance manual**.

2.1.3 Reduction classes

TABLE OF REDUCTIONS FOR BEND SHAFTS AND CON-ROD HALF-BEARINGS			
Recovery classes (mm)	Upper Half-Bearing Code	Lower Half-Bearing Code	Grinding on the shaft pin diameter (mm)
0.25	90924100	90924400	Ø49.75 0/-0.02 Ra 0.4 Rt 3.5
0.50	90924200	90824500	Ø49.50 0/-0.02 Ra 0.4 Rt 3.5

2.1.4 Disassembly / Reassembly of bearings and shims

The type of bearings (taper roller) ensures the absence of axial clearance on the bend shaft. The shims are defined to meet this necessity. For disassembly / reassembly and for any replacements, carefully observe the following directions:

A) Disassembly / Reassembly of the bend shaft without replacement of the bearings

After having removed the side covers as indicated in par. 2.1.1, check the conditions of the rollers and their relative tracks. If all parts are in good condition, clean the components carefully with a degreaser and redistribute lubricant oil uniformly. The previous shims can be reused, taking care to insert them only under the indicator side cover.

Once the complete unit (indicator side flange + shaft + motor side flange) is assembled and the cover screws have been tightened to the recommended torque, check that the rotation torque of the con-rod shaft - with the con-rod disconnected - is between 4 and 6 Nm.

To transition the two side covers closer to the casing, it is possible to use 3 M6x40 screws for the first positioning phase, as indicated above, and the screws provided for final fastening.

The shaft rotation torque (with the con-rods connected) should not exceed 8 Nm.

B) Disassembly / Reassembly of the bend shaft with replacement of the bearings

After removing the side covers, as described above, remove the outer ring nut on the bearings from its seat on the covers, using an appropriate extractor as shown in Fig. 12 and Fig. 12/a.

Remove the inner ring nut on the bearings from the two ends of the shaft, again using an appropriate extractor or, alternatively, a simple "pin punch" as shown in Fig. 13.

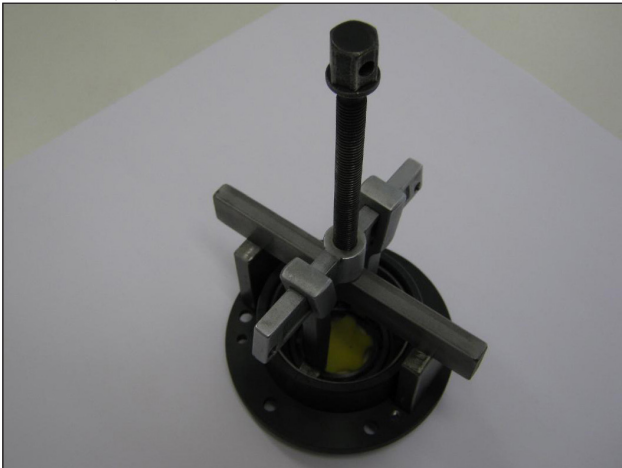

Fig. 12

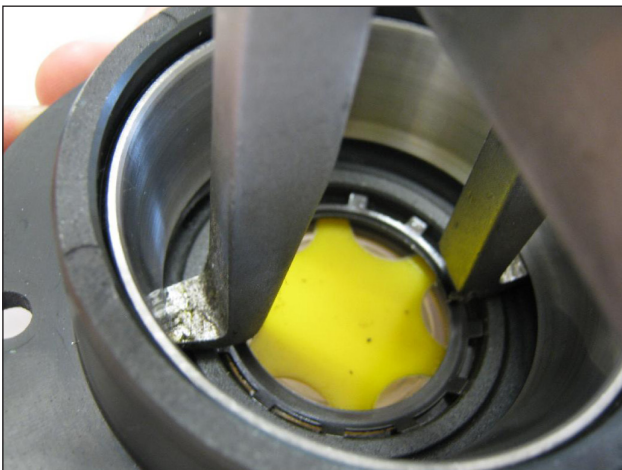

Fig. 12/a



Fig. 13

The new bearings can be mounted cold with a press or rocker, supporting them on the side surface of the ring nuts involved in press fitting with the rings. The press fitting operation can be facilitated by heating the involved parts to a temperature between 120°C - 150°C (250°F - 300°F), ensuring that the ring nuts fit fully into their seats.



Never exchange the parts of the two bearings.

Determining the shim pack:

Perform the operation while the piston/con-rod guide units are assembled, the con-rod caps are disconnected and the con-rods are pushed downwards. Insert the pump shaft without tab into the casing, making sure the PTO shank comes out of the correct side.

Secure the PTO side flange to the casing, taking care with the lip seal as described previously and tighten the fixing screws to the recommended torque.

Then feed the flange on the indicator side without shims in the carter and start to move it closer, manually screwing the M6x40 service screws in equally, with small rotations such as to move the cover in slowly and correctly.

At the same time, check that the shaft rotates freely by turning it manually.

Continuing the procedure in this way, a sudden increase in hardness during shaft rotation will soon be experienced.

At this point, halt the forward movement of the cover and loosen the fixing screws completely.

With the aid of a feeler gauge, measure the clearance between the side cover and pump casing (see Fig. 14).



Fig. 14

Proceed to determine the shim pack, using the table below:

Detected Measurement	Shim Type	# pieces
From: 0.05 to: 0.10	/	/
From: 0.11 to: 0.20	0.1	1
From: 0.21 to: 0.30	0.1	2
From: 0.31 to: 0.35	0.25	1
From: 0.36 to: 0.45	0.35	1
From: 0.46 to: 0.55	0.35	1
	0.10	1
From: 0.56 to: 0.60	0.25	2
From: 0.61 to: 0.70	0.35	1
	0.25	1



Fig. 15

Once the type and number of shims have been determined using the table, check the following: assemble the shim pack on the indicator side cover centring (Fig. 15), secure the cover to the casing, following the procedure in par. 2.1.2, and tighten the screws to their recommended torque.

Check that the shaft rotation stall torque is between 4 Nm and 6 Nm.

If this torque is correct, connect the con-rods to the bend shaft and to the next stages. If it is not, redefine the shim pack, repeating the operations.

2.2 REPAIRING HYDRAULIC PARTS

2.2.1 Dismantling the head-valve units

The head does not require any routine maintenance. Operations are limited to inspection or replacement of valves, if necessary.

Proceed as follows to extract valve units:

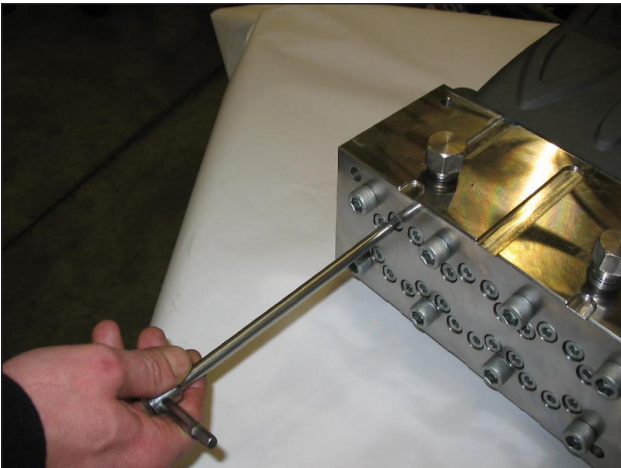

Fig. 16



- Loosen but do not remove the M8x100 screws fastening the liners to the head, as shown in Fig. 16, so as to free them.

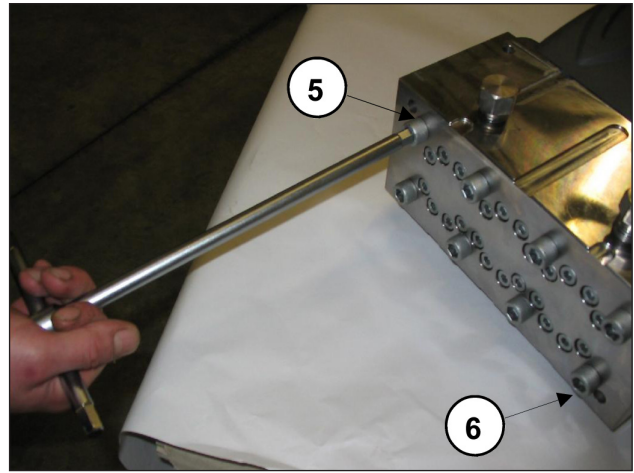

Fig. 17

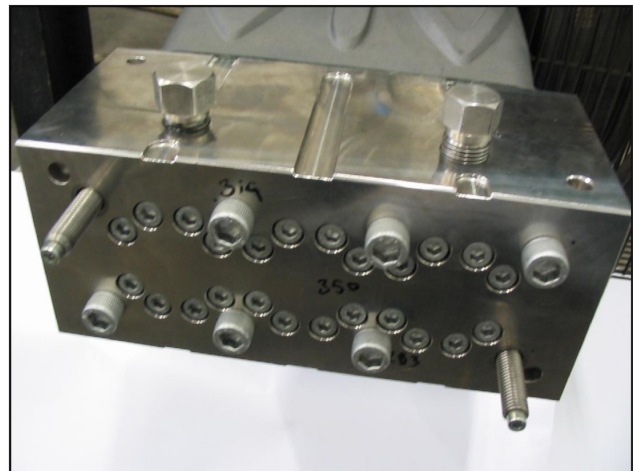

Fig. 18

- Unscrew the M12x260 head fixing screws No. 5 and No. 6 as shown in Fig. 17 replacing them with two service pin-screws (code 27508200) as shown in Fig. 18. Then take out the remaining screws.



Fig. 19

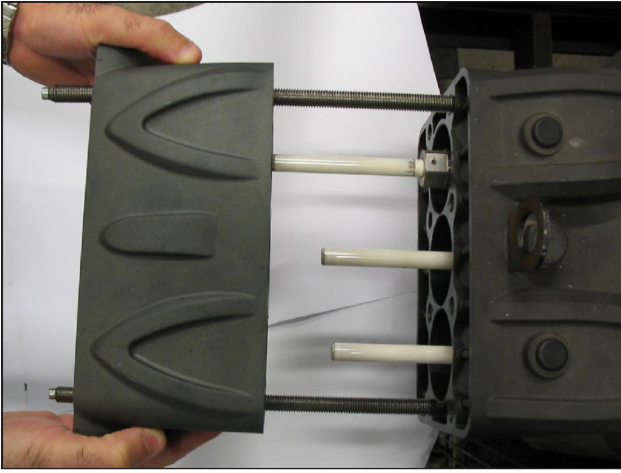

Fig. 20

- Separate the head and the spacer for the liners from the pump casing as shown in Fig. 19 and Fig. 20.



Fig. 21

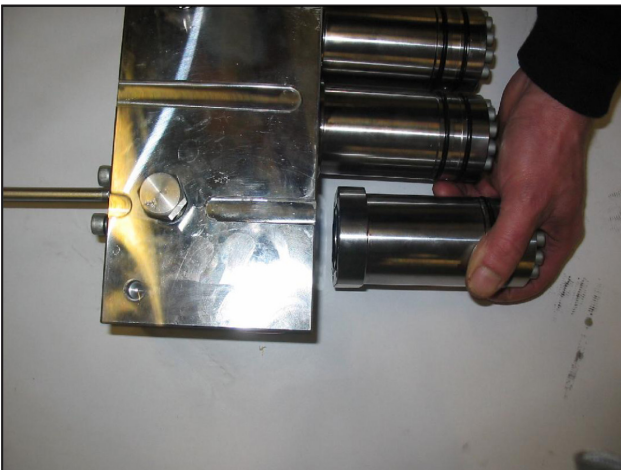

Fig. 22

- Take out the M8x100 screws fastening the liners to the head as shown in Fig. 21 and proceed as shown in Fig. 22.

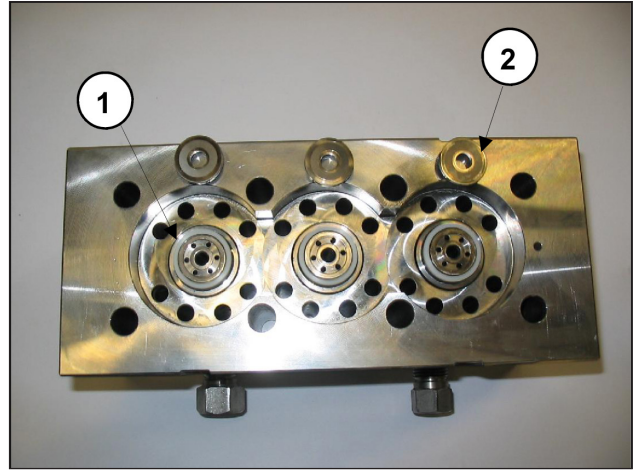

Fig. 23



When removing the liners, take care not to lose the valve seats ① and the flat valves ② as shown in Fig. 23 which, being only laid down, could fall.

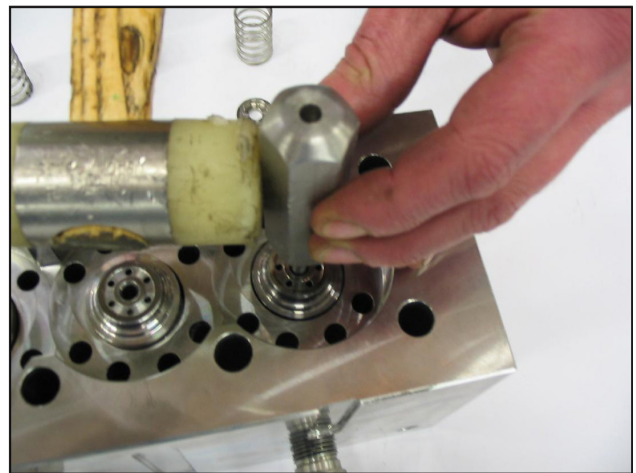

Fig. 24



If the valve seats are blocked on the head due to the formation of scale or oxide, they must be freed by inserting the tool (code 27508000 "VF12" - "VF14") into the suction hole and operating as in Fig. 24.

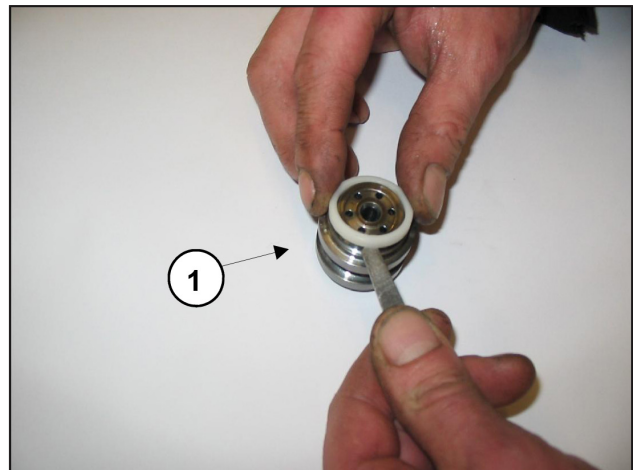

Fig. 25

- Extract the valve seats ① as shown in Fig. 25, check the various components for wear and replace them if necessary.



At every valve inspection, always replace all the sealing rings and the O-rings between the liner and the head, between the head and the liner spacer in the area of the recirculation hole. Before reassembly, clean and dry off the components and all their seats inside the head.

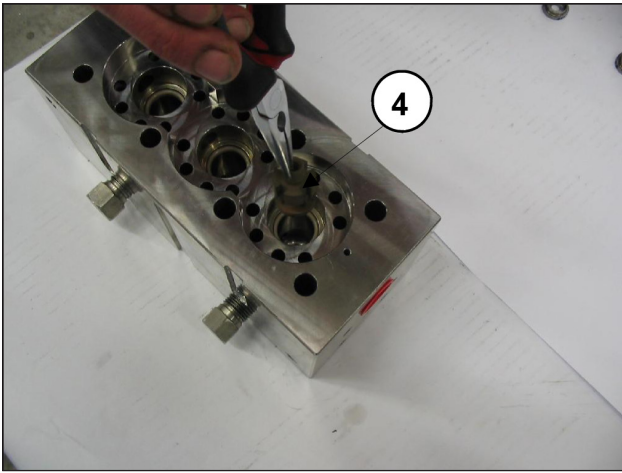

Fig. 26

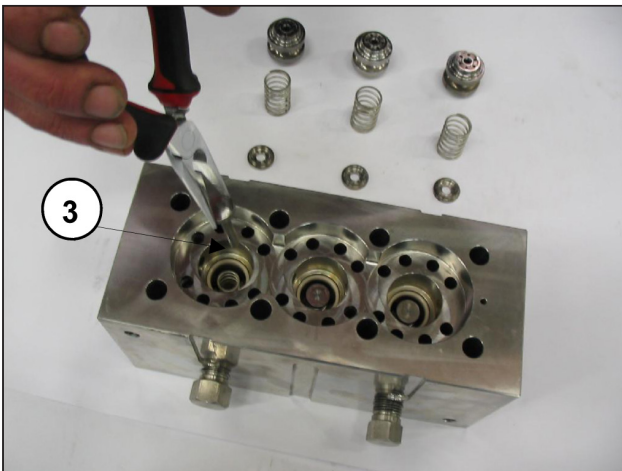

Fig. 27

- Extract the outlet plates ③ and their guides ④ with the springs, as shown in Fig. 26 and Fig. 27, check for wear and replace if necessary, and in any case within the times indicated in the "PREVENTIVE MAINTENANCE" table of chapter 11 in the **Use and maintenance manual**.

2.2.2 Reassembling the head - liners - valves



To reassemble the components, invert the previously listed operations, paying attention to the correct assembly of the liner spacer: when the component is mounted, the two rough casting exhausts present on one of the sides must be oriented towards the lower part of the casing (pump bracket side).

Heads - liners: proceed with assembly and head screw calibration, and then continue with the calibration of the liner fastening screws.

For the tightening torques and the various phases, follow the instructions in chapter 3.

2.2.3 Disassembly of the piston unit – supports – seals

The piston unit does not require any routine maintenance. Service operations are limited to the visual inspection of the cooling circuit's draining. In case of anomalies / oscillations on the delivery pressure gauge, or pulsating of the cooling circuit's draining pipe (if flexible), seal packings must be inspected and replaced if necessary.

Proceed as follows to remove the piston units.

- Separate the head and the spacer for the liners from the pump casing as shown in par. 2.2.1 (Fig. 19, Fig. 20).

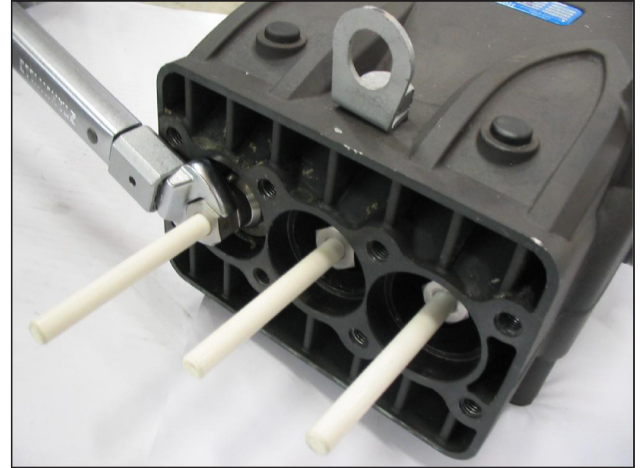

Fig. 28

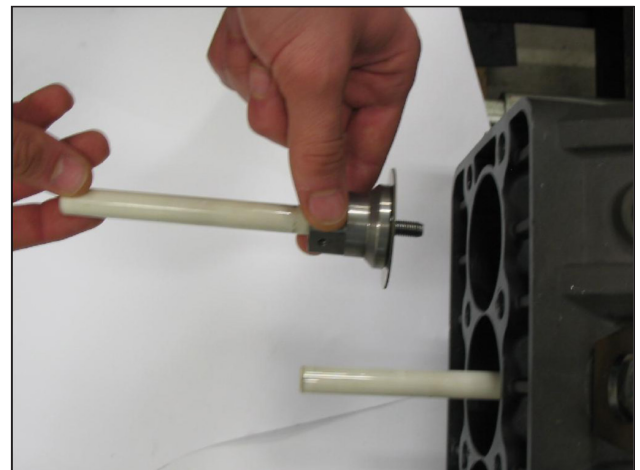

Fig. 29

- Remove the pumping elements with a fork wrench and check for wear as indicated in Fig. 28 and Fig. 29, replace them if necessary.
- Take out the M6x40 screws of the liner support as shown in Fig. 30 and separate the support as shown in Fig. 31.



Fig. 30

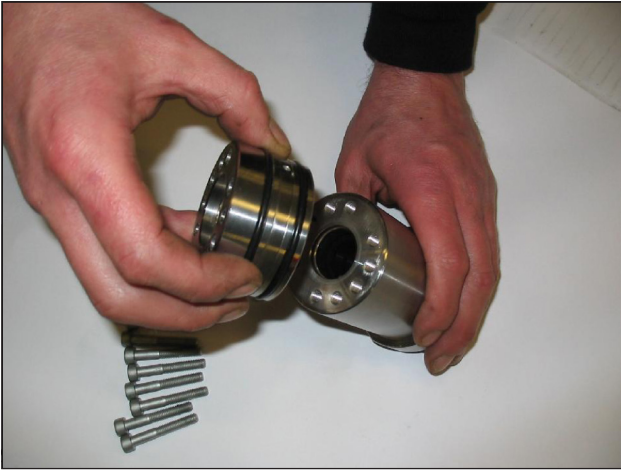

Fig. 31

- Remove the seeger ring and the seal retainer ring as shown in Fig. 32, and using a special plastic pin extract the LP (low pressure) seal ① as shown in Fig. 33.



Fig. 32

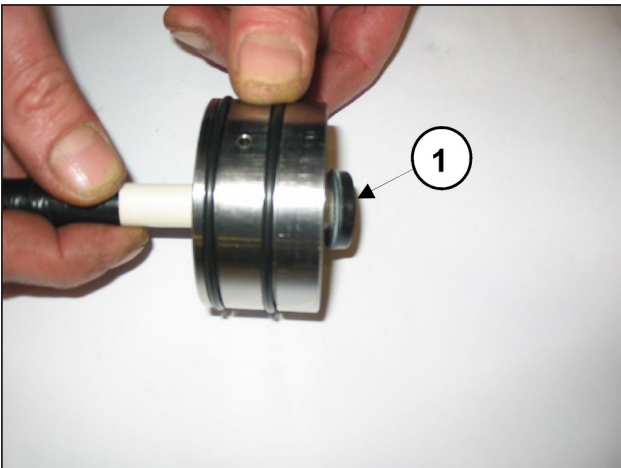

Fig. 33

- ⚠ At each disassembly, the low pressure seals and all the O-rings must be replaced.

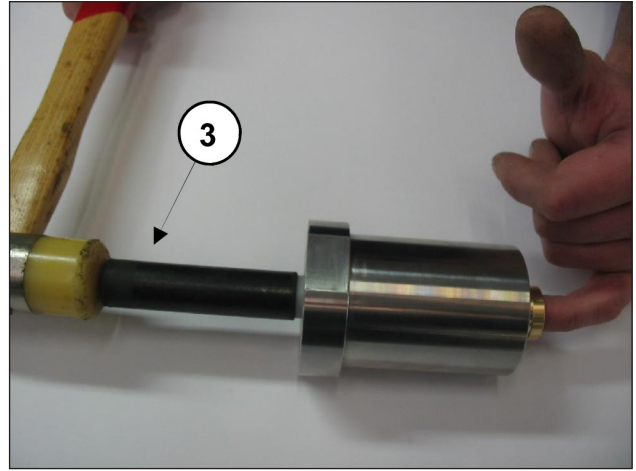

Fig. 34

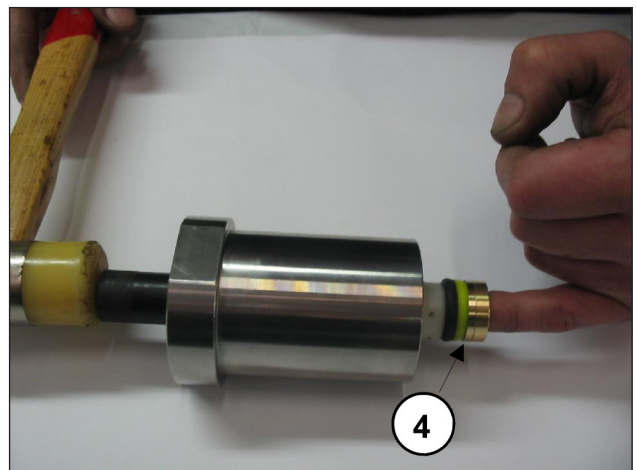

Fig. 35

- With the liner separated from the sealing support and with a special plastic pin ③ as shown in Fig. 34 drive out the HP (high pressure) seal ④ as shown in Fig. 35.

- ⚠ At each disassembly, the HP packing (Fig. 31, pos. ④) must be replaced.

2.2.4 Reassembly of the piston unit – supports – seals

To reassemble the components, invert the operations described above, paying attention to the sequences listed below; for the fastening torque values and phases, observe the instructions given in paragraph 3.

- Insert the upper bush into the liner.



Fig. 36



Fig. 37



For the correct axial positioning of the bush, use the special tool (code 27508300 valid for VF12 type pumps, and code 27508500 valid for VF14 type pumps) as shown in Fig. 36 and Fig. 37.



Fig. 38

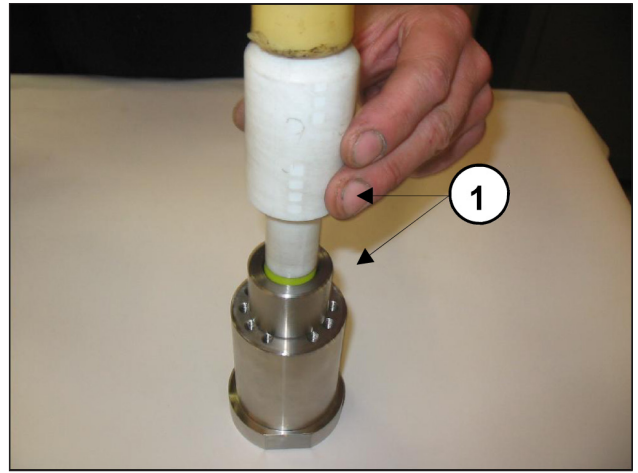

Fig. 39

- Insert the H.P. (high pressure) packing; considering the slight interference between the seal and the liner, to avoid damage we advise using the tool indicated in Fig. 38 and Fig. 39 pos. ① (code 27508400 and code 27365300).

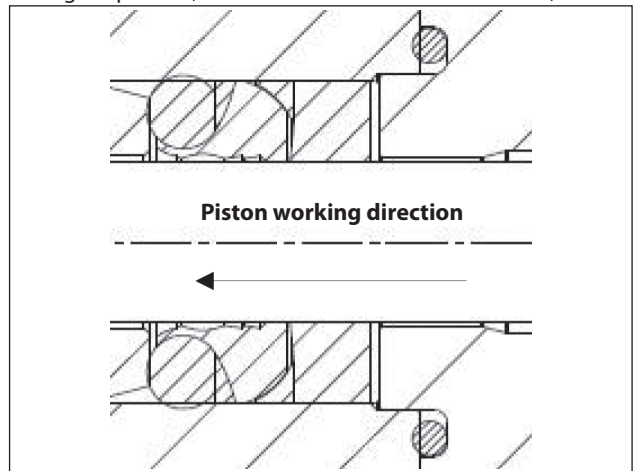

Fig. 40

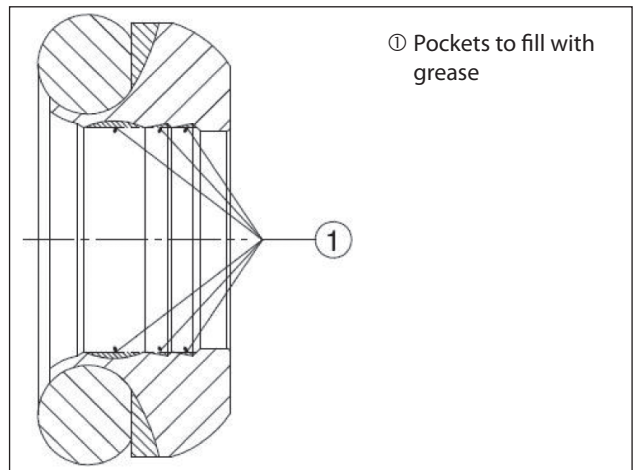

Fig. 40/a



The H.P. seal must be inserted into the liner with the energizing O-ring in the working direction of the piston as shown in Fig. 38 and Fig. 40.



Before inserting them into their seats, the H.P. seals must be lubricated with silicone grease Type OKS1110, following the operations listed below:

- The external diameter must only be slightly greased;
- On the internal diameter, grease must be applied paying great attention to filling all the pockets between the sealing lips as shown in Fig. 40/a.

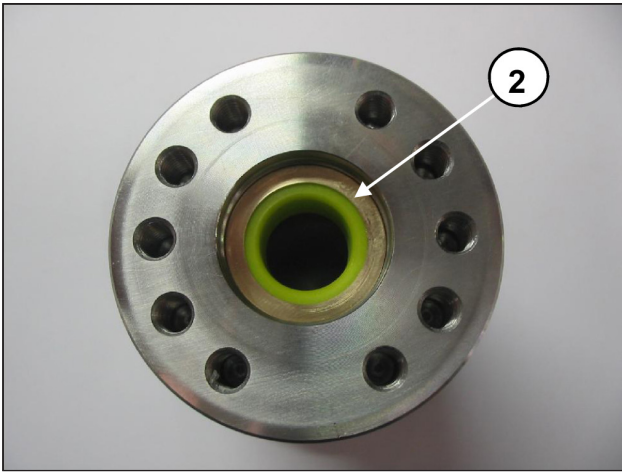

Fig. 41

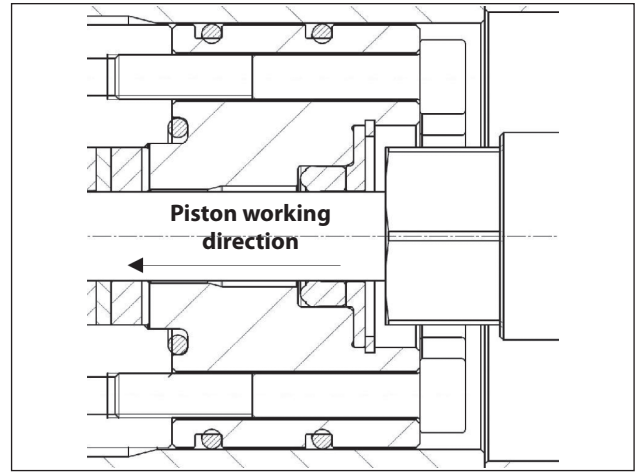

Fig. 44

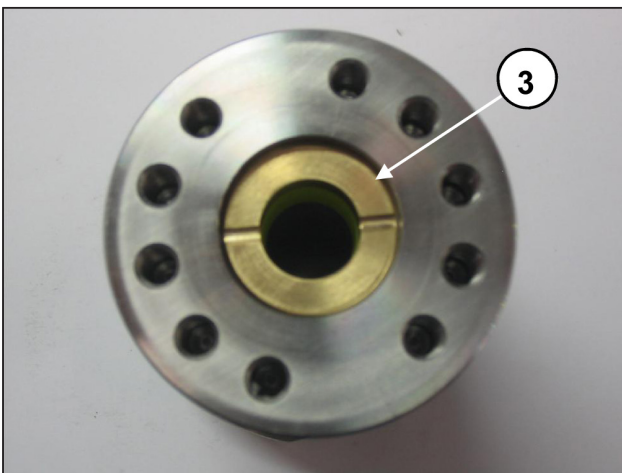

Fig. 42



Fig. 45

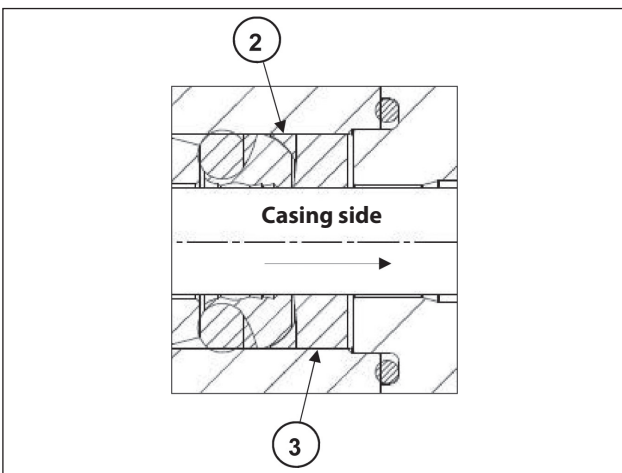

Fig. 43

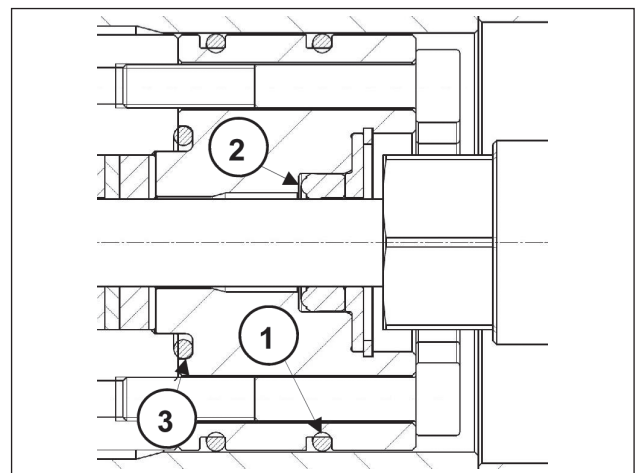

Fig. 46

- Insert the anti-extrusion ring ② and the gasket bush ③ arranged as shown in Fig. 41, Fig. 42, Fig. 43.
- ⚠ The gasket bush ③ must be introduced into the liner with the outlets facing outwards (casing side) as shown in Fig. 42 and in Fig. 43.
- ⚠ The L.P. seal must be inserted into the liner with the sealing lip in the piston working direction as shown in Fig. 44 and Fig. 45, slightly lubricating the external diameter with silicone grease type OKS 1110.

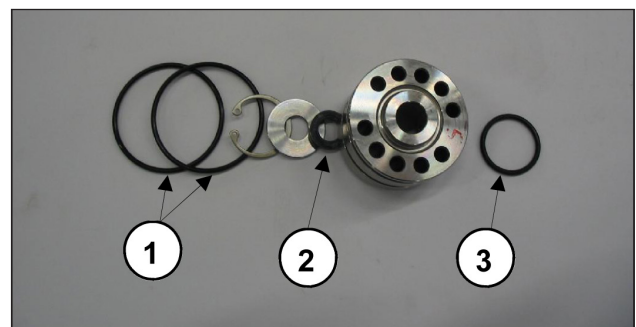

Fig. 47

- Reassemble the seals support unit as shown in Fig. 46 and Fig. 47 replacing components ①②③.



Fig. 48

- Assemble the support - liner unit by manually screwing the M6x40 screws as shown in Fig. 48. Then proceed with calibration using a torque wrench as indicated in chapter 3.

3 SCREW TIGHTENING CALIBRATION

Screw tightening must only be performed with a torque wrench.

Description	Exploded view position	Tightening torque Nm
Cover Fixing Screw	9	10
Oil drain plug	11	40
Lifting bracket fixing screw	17	40
Con-Rod Cap Fixing Screw	16	30*
Piston Fixing	28	20
Choke Fitting	31	10
Support Fixing Screw	44	15****
Head Fixing Screw	57	80**
Liner Fixing Screw	56	35***
Hydraulic Mot. Flange Screw	64	40

- * The con-rod cap fixing screws must be tightened respecting the phases indicated on pag. 20.
- ** The head fixing screws must be tightened respecting the phases and order shown in the diagram in Fig. 50.
- *** The liner fixing screws must be tightened respecting the phases and order shown in the diagram in Fig. 50.
- **** The supports fixing screws must be tightened respecting the phases and order shown in the diagram in Fig. 49.

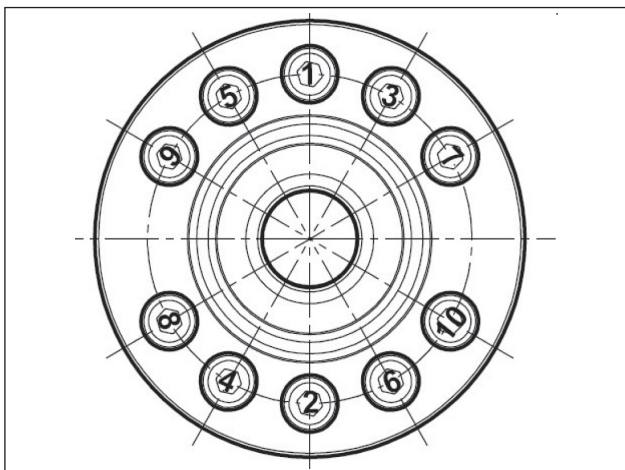

Fig. 49



The screws - pos. 44-57 - must be tightened by means of a torque wrench after lubricating the thread.

Head and liner screw fastening

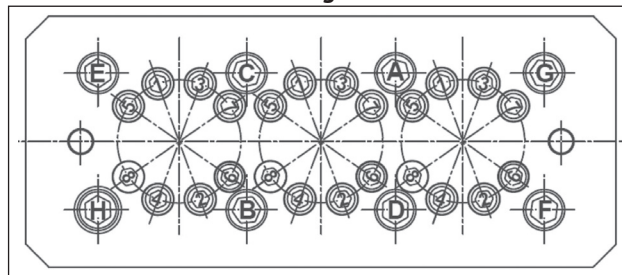

Fig. 50

OPERATION 1: Tightening M12x260 screws (pos. 56) in two phases observing the sequence indicated in figure: (A-B-C-D-E-F-G-H)

Phase 1 = 40 Nm

Phase 2 = 80 Nm

OPERATION 2: Tightening M8x100 screws (pos. 57) in four phases observing the sequence indicated in figure: (1-2-3-4-5-6-7-8)

Phase 1 = 20 Nm

Phase 2 = 30 Nm

Phase 3 = 35 Nm

Phase 4 = 35 Nm

4 REPLACING THE CON-ROD FOOT BUSH

During maintenance, if it becomes necessary to replace the con-rod foot bush, proceed as follows:



When removing the worn bushing, take great care not to damage or scratch the seat on the con-rod.

Perform cold press fitting of the new bush. During this operation, ensure that:

- the lubrication hole coincides with the corresponding hole on the con-rod;
- the cutting junction is directed as shown in Fig. 51.



Then perform mechanical processing. The dimensions and tolerances shown in Fig. 51 must be respected.

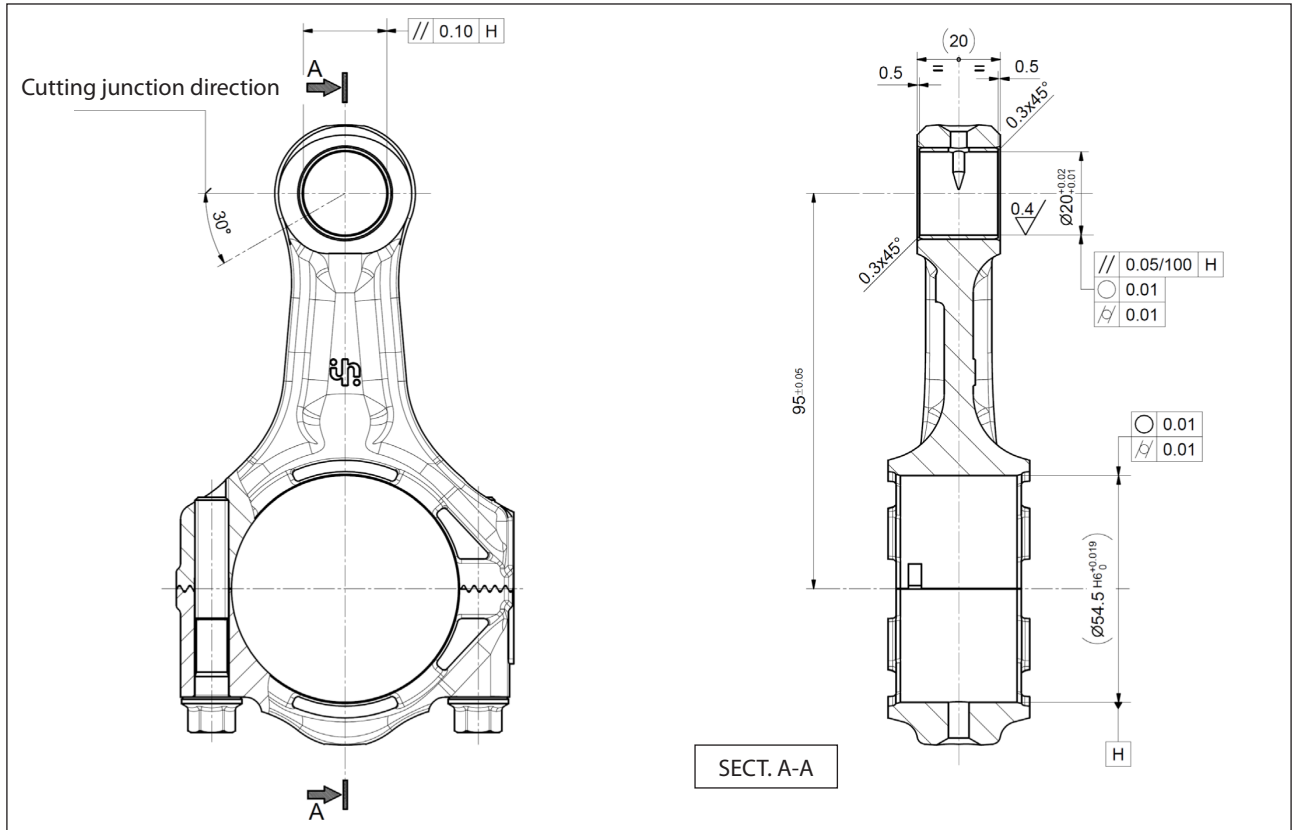

Fig. 51

5 REPAIR TOOLS

Pump repairs can be facilitated by special tools coded as follows:

For assembly phases:

Seal bush VF12; HP alternative seal ring Ø 12x24x13	code 27508400
	code 27365300
Seal bush VF14; HP alternative seal ring Ø 14x24x13	code 27508400
	code 27365300
Head assembly stud (2 pieces)	code 27508200
Bush for piston Ø12	code 27508300
Bush for piston Ø14	code 27508500
Buffer for pump shaft oil seal	code 27904800
Buffer for piston guide oil seal	code 27904900

For disassembly phases:

VF12 - VF14 valve seats	code 27508000
Head assembly stud (2 pieces)	code 27508200
Piston guide oil seal	code 27503900
	code 26019400

Sommaire

1	INTRODUCTION	31
1.1	DESCRIPTION DES SYMBOLES	31
2	CONSIGNES DE RÉPARATION	31
2.1	RÉPARATION DE LA PARTIE MÉCANIQUE	31
2.1.1	<i>Démontage de la partie mécanique</i>	31
2.1.2	<i>Remontage de la partie mécanique</i>	33
2.1.3	<i>Classes de minoration prévues</i>	34
2.1.4	<i>Désassemblage / Réassemblage des roulements et des bagues d'usure</i>	35
2.2	RÉPARATION DE LA PARTIE HYDRAULIQUE	36
2.2.1	<i>Démontage de la tête -ensembles de soupapes</i>	36
2.2.2	<i>Remontage de la tête - chemises - soupapes</i>	38
2.2.3	<i>Démontage du groupe piston - supports - joints d'étanchéité</i>	38
2.2.4	<i>Remontage du groupe piston - supports - joints d'étanchéité</i>	40
3	FORCES DE SERRAGE DES VIS	42
4	REPLACEMENT DE LA DOUILLE PIED DE LA BIELLE	43
5	OUTILS POUR LA RÉPARATION	43

1 INTRODUCTION

Ce manuel décrit les instructions pour la réparation des pompes de la série VF et doit être attentivement lu et compris avant d'effectuer et de réaliser toute intervention sur la pompe.

Le bon fonctionnement et la durée de la pompe dépendent de l'usage correct et de l'entretien approprié effectué sur celle-ci.

Interpump Group décline toute responsabilité concernant les dommages causés par négligence et inobservation des consignes décrites dans ce manuel.

1.1 DESCRIPTION DES SYMBOLES

Lire attentivement ce qui est indiqué dans ce manuel avant de commencer toute opération.



Signal de Mise en garde



Lire attentivement ce qui est indiqué dans ce manuel avant de commencer toute opération.



Signal de Danger

S'équiper de lunettes de protection.



Signal de Danger

S'équiper de gants de protection avant chaque opération.

2 CONSIGNES DE RÉPARATION



2.1 RÉPARATION DE LA PARTIE MÉCANIQUE

Les opérations de réparation de la partie mécanique doivent être effectuées après avoir éliminé l'huile du carter.

Pour vidanger l'huile, retirer la jauge de niveau d'huile rep. ① puis le bouchon rep. ②, Fig. 1.

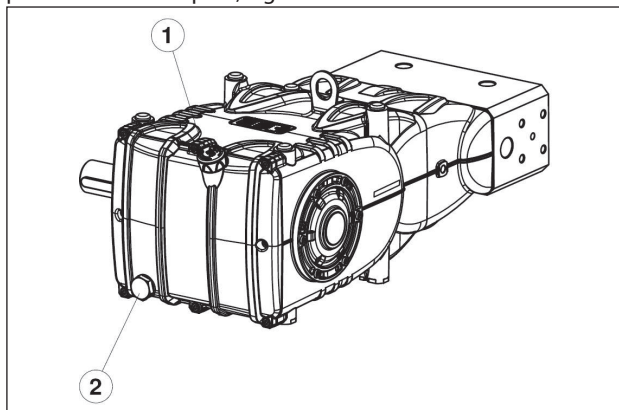

Fig. 1



Verser l'huile usagée dans un récipient spécial et l'éliminer auprès des centres autorisés. Elle ne doit en aucun cas être déversée dans l'environnement.

2.1.1 Démontage de la partie mécanique

Les opérations décrites doivent être effectuées après avoir retiré la partie hydraulique, les pistons céramiques et les déflecteurs de la pompe (parag. 2.2.3, 2.2.4).

Pour une séquence correcte, démonter dans l'ordre suivant :

- la clavette de l'arbre de la pompe
- le couvercle arrière
- le chapeau des bielles de la façon suivante : dévisser les vis de fixation du chapeau, extraire les chapeaux de la bielle avec les demi-coussinets inférieurs (Fig. 2) en faisant attention lors du démontage de suivre l'ordre des numéros.

Pour éviter toute erreur possible, les chapeaux et les corps de la bielle ont été numérotés sur un côté (Fig. 2/a, rep. ①).

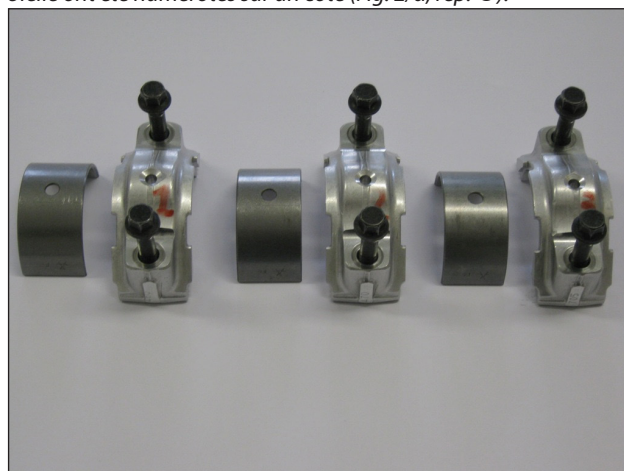

Fig. 2

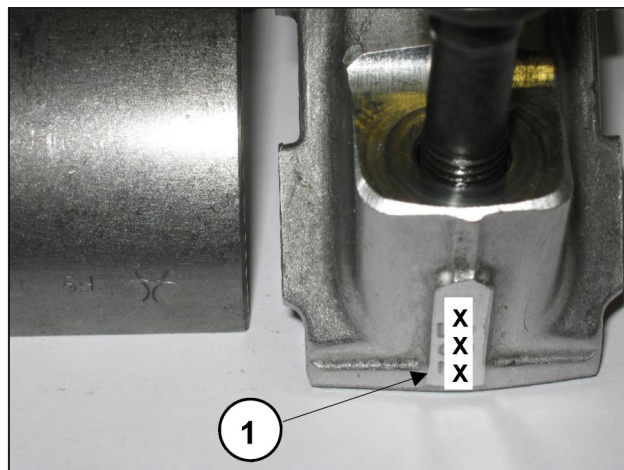

Fig. 2/a

- les couvercles latéraux en utilisant – pour l'extraction, 3 vis M6x50 entièrement filetées, et en les insérant dans les orifices filetés, comme l'indique la Fig. 3.

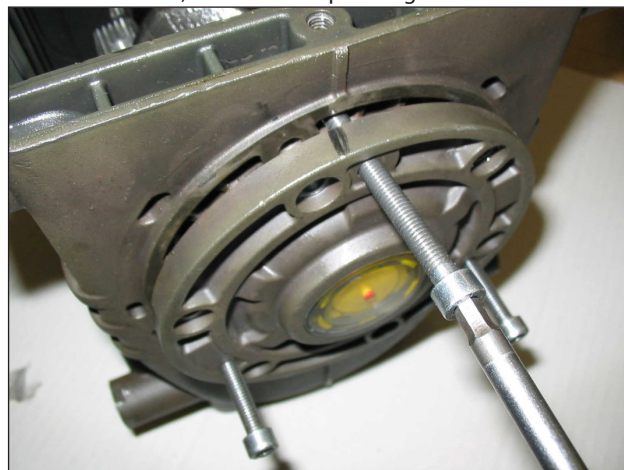

Fig. 3

- Pousser en avant les guides du piston avec les bielles correspondantes pour faciliter l'extraction latérale de l'arbre de la pompe. L'arbre présente deux repères (1 sur les Fig. 4 et Fig. 4/a) qui doivent être tournés vers l'opérateur de sorte à faciliter leur extraction.

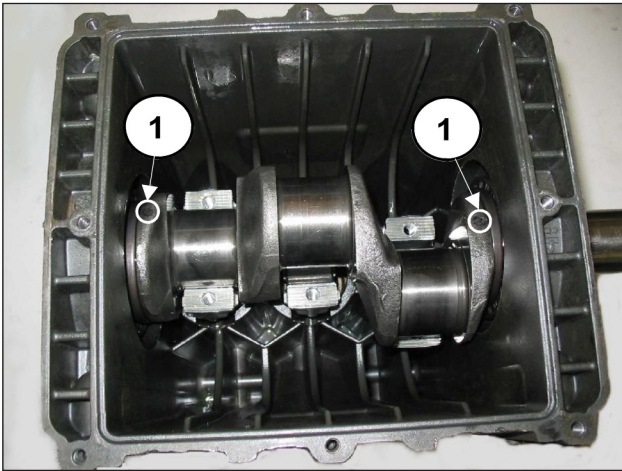

Fig. 4

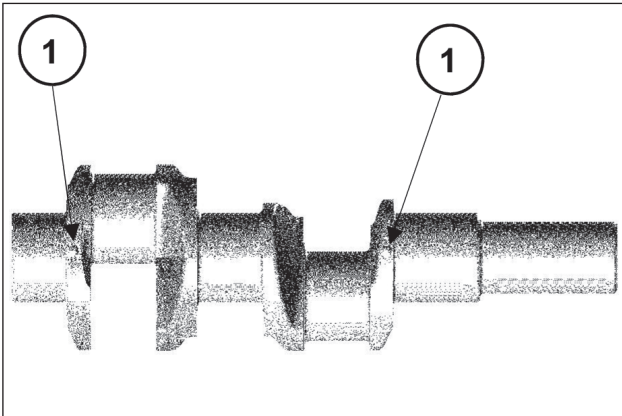

Fig. 4/a

- Extraire l'arbre de la pompe
- Terminer le démontage des groupes de la bielle en les retirant du carter de la pompe et en enlevant les axes des guides du piston.
- Démontez les bagues d'étanchéité de l'arbre de la pompe avec des outils ordinaires.
- Démontez les bagues d'étanchéité des guides piston en suivant la procédure décrite : utiliser l'extracteur réf. 26019400 (Fig. 5, rep. ①) et la pince réf. 27503900 (Fig. 5, rep. ②). Insérer la pince à fond sur la bague d'étanchéité à l'aide d'un marteau (Fig. 5/a) puis visser l'extracteur sur la pince et intervenir sur la masse d'inertie de l'extracteur (Fig. 5/b) jusqu'à extraire la bague à remplacer (Fig. 5/c).



Fig. 5/a



Fig. 5/b



Fig. 5/c

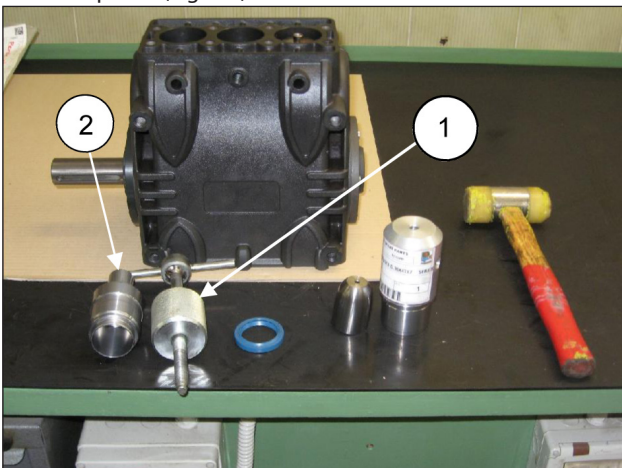

Fig. 5

2.1.2 Remontage de la partie mécanique

Après avoir vérifié la propreté du carter, on peut procéder au montage de la partie mécanique en suivant la procédure décrite :



- Monter les demi-coussinets supérieurs et inférieurs dans les sièges respectifs des bielles et des chapeaux.

S'assurer que les crans de repère des demi-coussinets supérieur (Fig. 6, rep. ①) et inférieur (Fig. 6/a, rep. ②) se trouvent dans les sièges respectifs de la bielle et du chapeau.

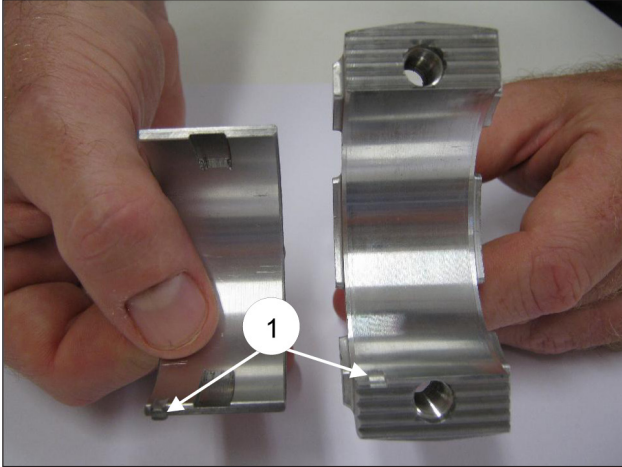

Fig. 6

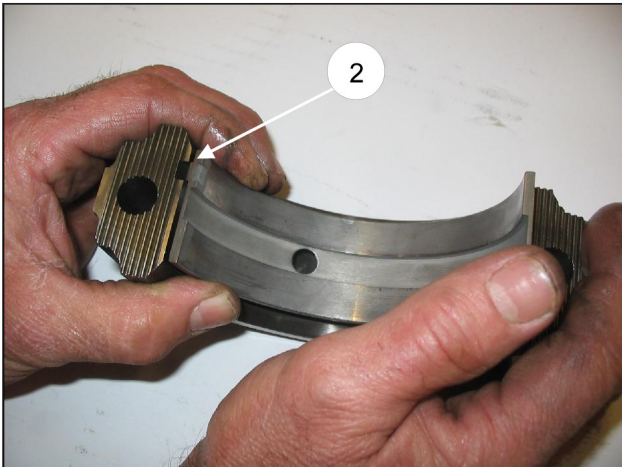

Fig. 6/a

- Introduire dans le carter de la pompe les groupes guide du piston / bielle en orientant la numérotation présente sur le corps de la bielle vers le haut du carter.

Pour faciliter l'introduction de l'arbre de la pompe (sans clavette), il est indispensable de répéter l'opération effectuée lors du démontage en poussant à fond les groupes guide du piston / bielle (parag. 2.1.1).

- Avant de procéder au montage du couvercle latéral côté P.T.O., vérifier les conditions de la lèvre d'étanchéité du joint radial et de la zone de contact relative sur l'arbre. S'il s'avère nécessaire de remplacer le joint, placer le nouveau en utilisant l'outil approprié (réf. 27904800) comme le montre la Fig. 7.



Si l'arbre de la pompe présente une usure diamétrale dans la zone de contact avec la lèvre d'étanchéité, afin d'éviter l'opération de rattrapage, il est possible de repositionner le joint en butée avec le couvercle, comme l'indique la Fig. 7.

Avant de monter les couvercles latéraux, s'assurer de la présence des joints toriques d'étanchéité et des bagues d'appui uniquement sur le couvercle côté voyant.

Pour faciliter l'insertion du premier tronçon et donc l'insertion des couvercles sur le carter, il est conseillé d'utiliser 3 vis M6 x 40 partiellement filetées (Fig. 8, rep. ①) pour ensuite compléter l'opération avec les vis fournies (M6x18).

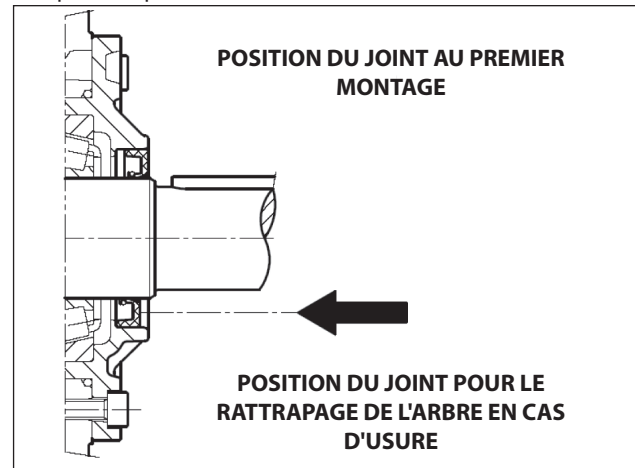

Fig. 7

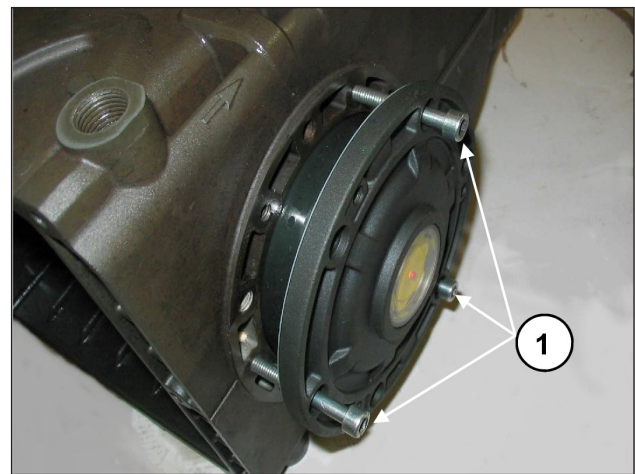

Fig. 8



- Assembler les chapeaux de la bielle aux corps relatifs en se référant à la numérotation (Fig. 9, rep. ①).

Faire attention au sens de montage des chapeaux.

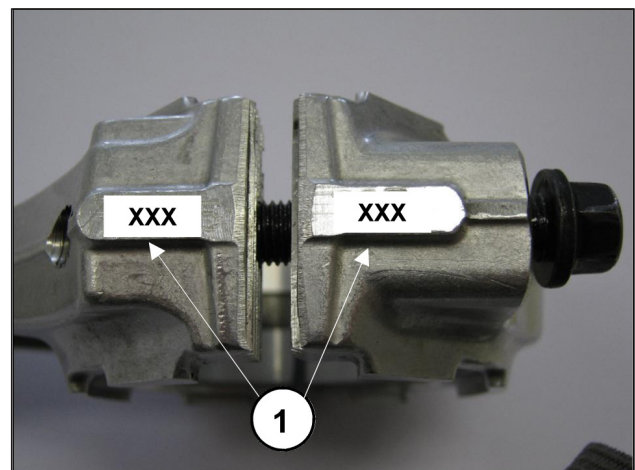

Fig. 9

- Fixer les chapeaux sur les corps respectifs de la bielle au moyen des vis M8x1x48 (Fig. 10) en lubrifiant aussi bien le collet que la tige filetée, et en procédant en deux phases différentes :



1. Visser manuellement les vis jusqu'au début du serrage
 2. Couple de serrage **30 Nm**
- En alternative, effectuer :
1. Couple de pré-serrage **10-15 Nm**
 2. Couple de serrage **30 Nm**

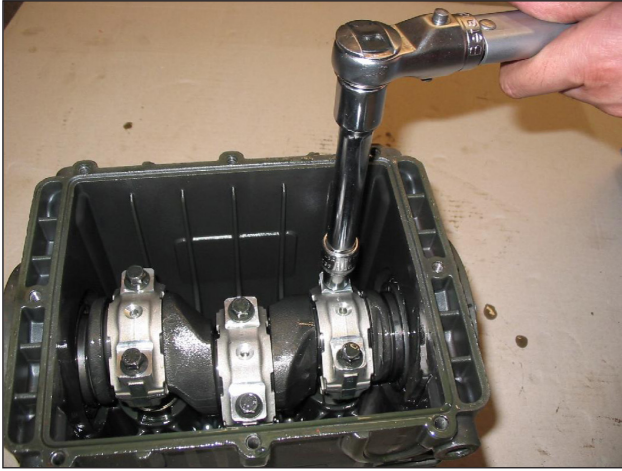

Fig. 10

- Après avoir achevé l'opération de serrage, vérifier que la tête de la bielle ait un jeu latéral dans les deux sens.
- Monter les nouvelles bagues d'étanchéité des guides du piston jusqu'à la butée avec le siège relatif situé sur le carter de la pompe (Fig. 11) en suivant la procédure décrite :
utiliser l'outil réf. 27904900 composé d'une douille conique et d'un tampon. Visser la douille conique dans l'orifice présent sur le guide du piston (Fig. 11/a), insérer la nouvelle bague d'étanchéité sur le tampon et l'amener jusqu'à la butée (déterminée par la hauteur du tampon) dans son propre siège sur le carter de la pompe (Fig. 11/b), retirer la douille conique (Fig. 11/c).

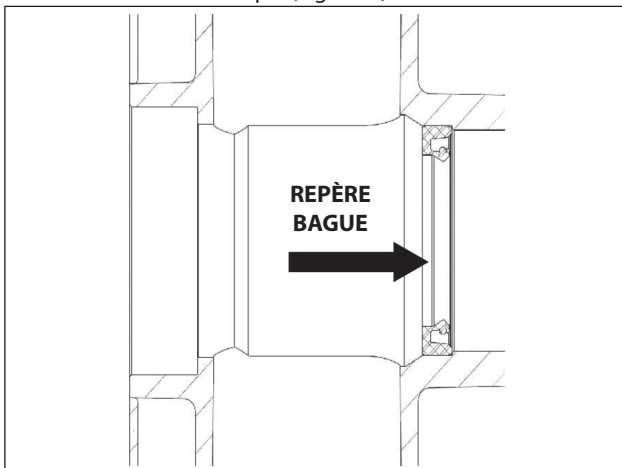

Fig. 11



Fig. 11/a



Fig. 11/b



Fig. 11/c

- Monter le couvercle arrière avec le joint torique d'étanchéité, en tournant l'orifice de la tige du niveau d'huile vers le haut.
- Verser l'huile dans le carter comme en suivant les explications du **Manuel d'utilisation et entretien**.

2.1.3 Classes de minorations prévues

TABLEAU DE MINORATIONS POUR VILEBREQUIN ET DEMI-COUSSINETS DE BIELLE			
Classes de rattrapage (mm)	Code Demi-coussinet Supérieur	Code Demi-coussinet Inférieur	Rattrapage sur le diamètre du goujon de l'arbre (mm)
0.25	90924100	90924400	Ø49.75 0/-0.02 Ra 0.4 Rt 3.5
0.50	90924200	90824500	Ø49.50 0/-0.02 Ra 0.4 Rt 3.5

2.1.4 Désassemblage / Réassemblage des roulements et des bagues d'usure

La typologie des roulements (à rouleaux coniques) garantit l'absence du jeu axial du vilebrequin ; c'est dans ce but qu'on utilise les bagues d'usure. Pour le démontage / remontage et en cas de remplacement, suivre attentivement les indications suivantes :

A) Désassemblage / Réassemblage du vilebrequin sans remplacer les roulements

Après avoir démonté les couvercles latéraux, voir parag. 2.1.1, contrôler l'état des rouleaux et des pistes correspondantes ; si toutes les pièces sont jugées conformes, nettoyer soigneusement les composants avec un dégraissant et redistribuer de l'huile lubrifiante de façon uniforme. Les cales d'épaisseur précédentes peuvent être réutilisées en faisant attention à les insérer uniquement sous le couvercle du côté voyant.

Une fois que tout le groupe est monté (Flasque côté voyant + arbre + bride côté moteur) que les vis des couvercles sont serrées au couple prescrit, vérifier que le couple de rotation de l'arbre avec bielles non raccordées ait une valeur comprise entre 4 et 6 Nm. Pour l'assemblage des deux couvercles latéraux au carter, on peut utiliser 3 vis M6x40 pour une première phase d'orientation, comme préalablement indiqué, et les vis prévues pour la fixation finale.

Le couple de rotation de l'arbre avec bielles raccordées ne devra pas dépasser la valeur de 8 Nm.

B) Désassemblage / Réassemblage du vilebrequin avec remplacement des roulements

Après avoir démonté les couvercles latéraux, comme il est précédemment indiqué, retirer la bague externe des roulements situés dans leurs sièges sur les couvercles à l'aide d'un extracteur approprié comme l'indiquent les Fig. 12 et Fig. 12/a. Retirer la bague interne des roulements par les deux extrémités de l'arbre en utilisant toujours un extracteur approprié ou, dans l'alternative, un simple « chasse-clou » comme l'indique la Fig. 13.



Fig. 12

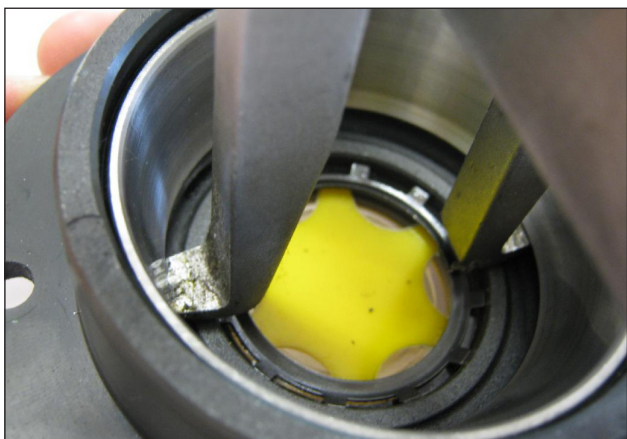

Fig. 12/a



Fig. 13

Les nouveaux roulements peuvent être montés à froid avec une presse ou un balancier, en les posant impérativement sur la surface latérale des bagues qui devront être fixées avec des anneaux. L'opération de fixation pourrait être facilitée en réchauffant les pièces intéressées à une température comprise entre 120° - 150°C. (250° - 300°F), tout en s'assurant que les bagues arrivent à la butée dans leurs sièges respectifs.



Ne jamais échanger les pièces des deux roulements.

Détermination du lot des bagues d'usure :

Effectuer l'opération avec des groupes guide du piston - bielle montés, les chapeaux de la bielle décrochés et les bielles poussées vers le bas. Insérer l'arbre de la pompe sans clavette dans le carter, en s'assurant que la queue P.T.O ressorte du côté prévu.

Fixer le flasque côté P.T.O. au carter, en faisant très attention à la lèvre de la bague d'étanchéité, et selon la procédure décrite précédemment, puis serrer les vis de fixation au couple prévu. Successivement, encastrer le flasque côté voyant sans cales dans le carter et commencer à le rapprocher en vissant manuellement les vis M6x40 de façon identique, avec de petites rotations permettant de générer une avance lente et correcte du couvercle.

Simultanément, vérifier que l'arbre tourne librement en le tournant manuellement.

En continuant la procédure selon cette modalité, on arrivera à percevoir une augmentation imprévue de dureté dans la rotation de l'arbre.

Interrompre l'avance du couvercle et desserrer complètement les vis de fixation.

À l'aide d'une jauge d'épaisseur, mesurer le jeu entre le couvercle latéral et le carter de la pompe (voir Fig. 14).



Fig. 14

Déterminer le lot des cales en utilisant le tableau ci-dessous :

Mesure Relevée	Type de Cale	Nbre de pièces
De : 0,05 à : 0,10	/	/
De : 0,11 à : 0,20	0,1	1
De : 0,21 à : 0,30	0,1	2
De : 0,31 à : 0,35	0,25	1
De : 0,36 à : 0,45	0,35	1
De : 0,46 à : 0,55	0,35 0,10	1 1
De : 0,56 à : 0,60	0,25	2
De : 0,61 à : 0,70	0,35 0,25	1 1



Fig. 15

Une fois que le type et le nombre de cales est déterminé au moyen du tableau, effectuer le contrôle suivant, monter le lot des cales sur le centre du couvercle côté voyant (Fig. 15), fixer le couvercle au carter en suivant la procédure du parag. 2.1.2, serrer les vis respectives au couple prévu.

Vérifier que le couple résistant de rotation de l'arbre ait une valeur comprise entre 4Nm et 6 Nm.

Si ce couple résulte correct, procéder au raccordement des bielles au vilebrequin, puis aux phases successives, dans le cas contraire, redéfinir le lot des cales en répétant les opérations.

2.2 RÉPARATION DE LA PARTIE HYDRAULIQUE

2.2.1 Démontage de la tête -ensembles de soupapes

La tête ne nécessite aucun entretien régulier.

Les interventions se limitent à l'inspection ou au remplacement des soupapes, en cas de besoin.

Pour l'extraction des groupes de la soupape, procéder de la façon suivante :

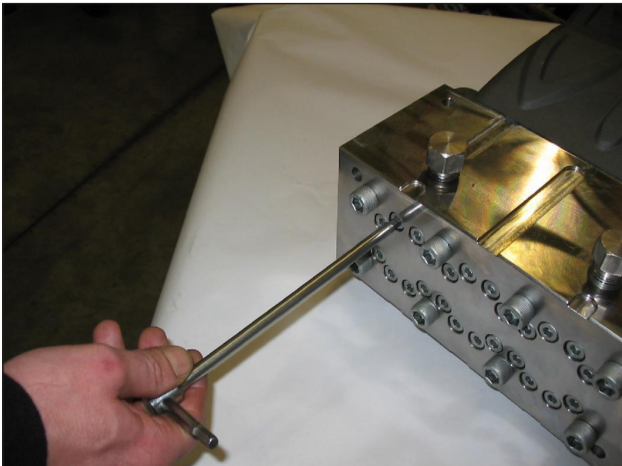

Fig. 16



- Desserrer sans les enlever les vis M8x100 de fixation de la chemise sur la tête, comme le montre la Fig. 16, de sorte à les dégager.

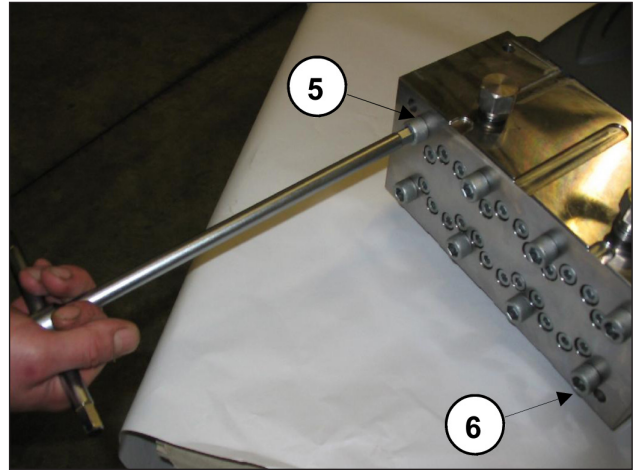

Fig. 17

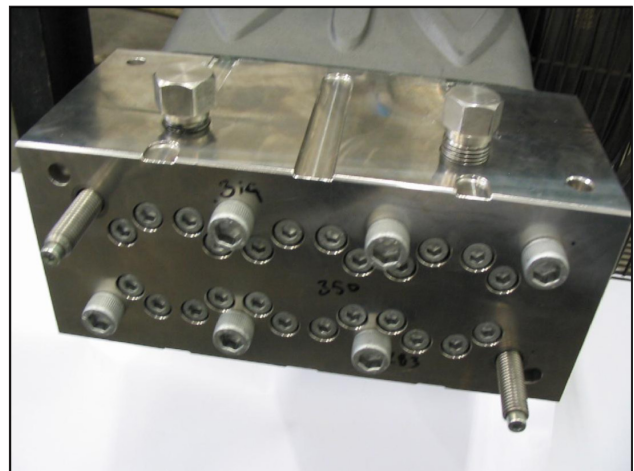

Fig. 18

- Dévisser les vis de fixation de la tête M12x260 n° 5 et n° 6 comme le montre la Fig. 17 et les remplacer par deux goujons de service (réf. 27508200) comme le montre la Fig. 18. Enlever les autres vis.



Fig. 19

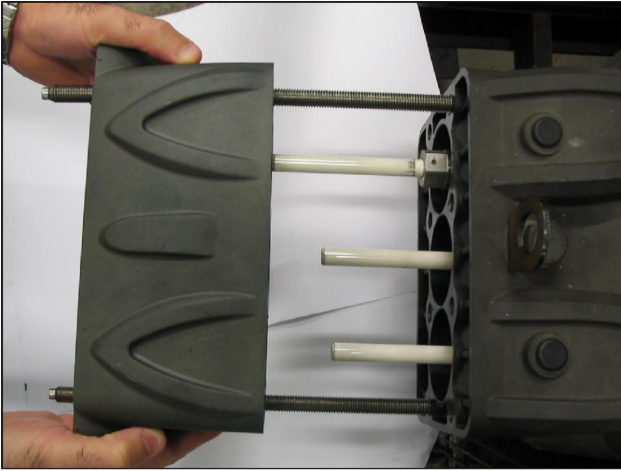

Fig. 20

- Désassembler la tête et l'entretoise de chemises du carter de pompe comme le montrent les Fig. 19 et Fig. 20.



Fig. 21

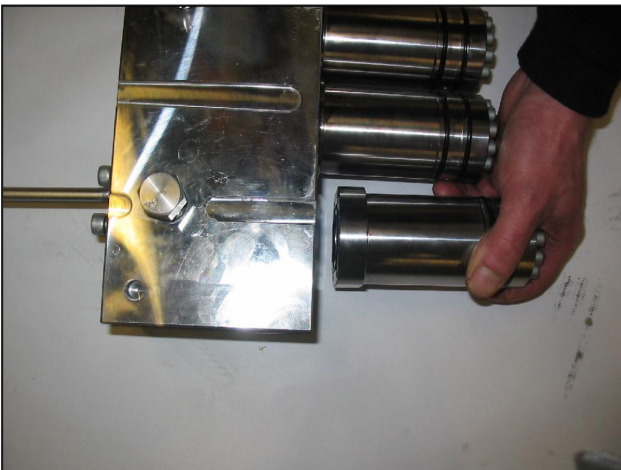

Fig. 22

- Enlever les vis M8x100 de fixation des chemises sur la tête comme le montre la Fig. 21 et procéder comme l'indique la Fig. 22.

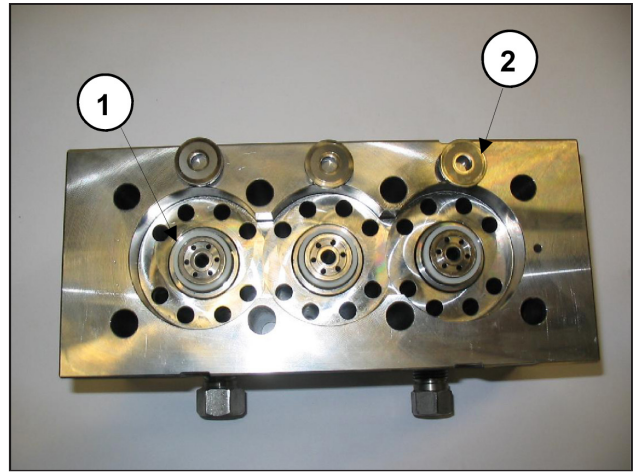

Fig. 23



Durant le démontage des chemises, faire attention à ne pas perdre les sièges de soupape ① et les soupapes plates ② comme le montre la Fig. 23 car elles pourraient tomber du fait qu'elles sont simplement posées sur le fond.

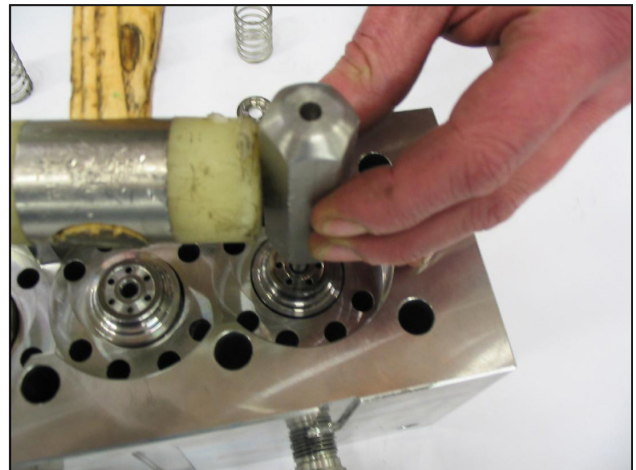

Fig. 24



Si les sièges de soupape résultent bloqués sur la tête à cause de la présence de calcaire ou s'ils sont oxydés, les débloquer en faisant passer l'outil (réf. 27508000 « VF12 » - « VF14 ») dans l'orifice d'aspiration comme le montre la Fig. 24.

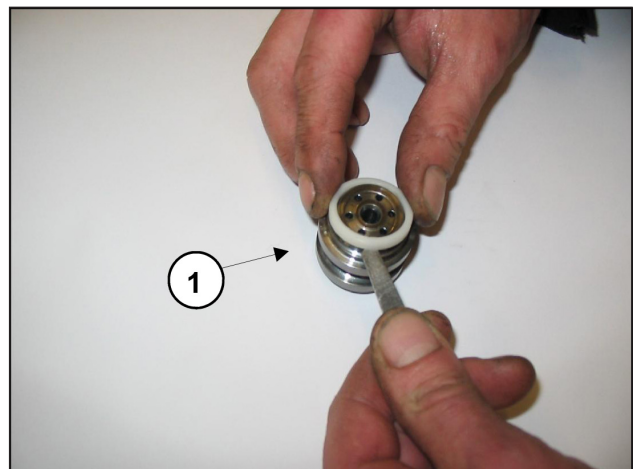

Fig. 25

- Dégager les sièges de soupape ① comme le montre la Fig. 25, contrôler si les composants sont usés et les remplacer si nécessaire.



Remplacer tous les joints d'étanchéité et les joints toriques correspondants à l'avant, entre la chemise et la tête, entre la tête et l'entretoise des chemises à proximité de l'orifice de recyclage, chaque fois que l'on procède au contrôle des soupapes.
Avant de procéder au remontage, nettoyer et essuyer les différents composants et tous leurs logements à l'intérieur de la tête.

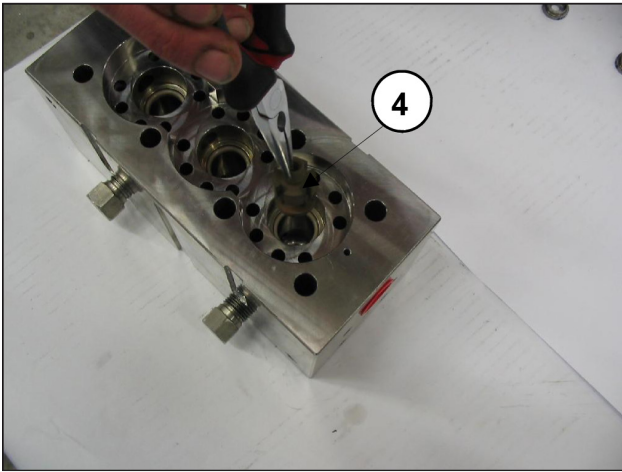

Fig. 26

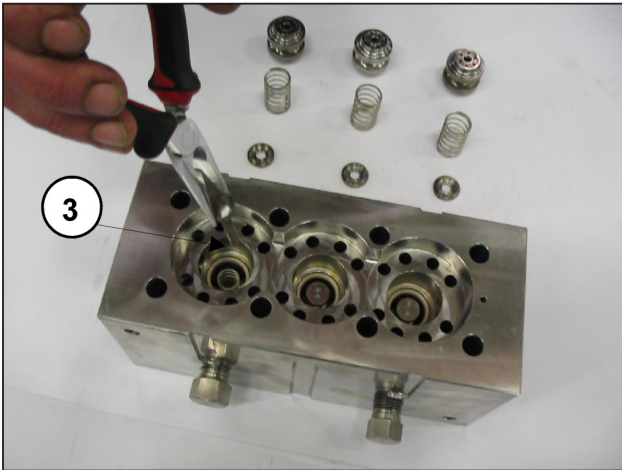

Fig. 27

- Sortir les plateaux de refoulement ③ et leurs guides ④ avec les ressorts correspondants, comme le montrent les Fig. 26 et Fig. 27, vérifier s'ils sont usés et les remplacer si nécessaire ; toujours les remplacer aux intervalles indiqués dans le tableau « ENTRETIEN PRÉVENTIF », chapitre 11 du **Manuel d'utilisation et entretien**.

2.2.2 Remontage de la tête - chemises - soupapes



Pour remonter les différents composants, inverser les opérations précédentes en ayant soin de remonter correctement l'entretoise des chemises : les deux dispositifs d'évacuation en fonte présents sur l'un des deux flancs doivent, une fois le composant réassemblé, être tournés vers la partie inférieure du carter (côté étrier de pompe).

Têtes - chemises : procéder au remontage et au réglage des vis de fixation de la tête puis au réglage des vis de fixation des chemises.

Pour les valeurs des couples de serrage et les différentes phases, respecter les indications figurant au chapitre 3.

2.2.3 Démontage du groupe piston - supports - joints d'étanchéité

Le groupe du piston ne nécessite aucun entretien régulier. Les interventions se limitent au simple contrôle visuel du drainage du circuit de refroidissement. En cas d'anomalies / oscillations sur le manomètre de refoulement ou de pulsations sur le tuyau de drainage du circuit de refroidissement (s'il est élastique), procéder à un contrôle et remplacer éventuellement le lot de joints.
Pour l'extraction des groupes du piston, procéder de la façon suivante :

- Désassembler la tête et l'entretoise de chemises du carter de pompe en suivant les explications au parag. 2.2.1 (Fig. 19, Fig. 20).

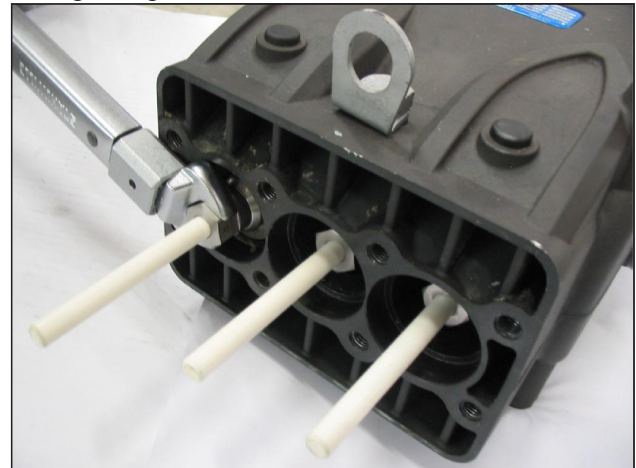

Fig. 28

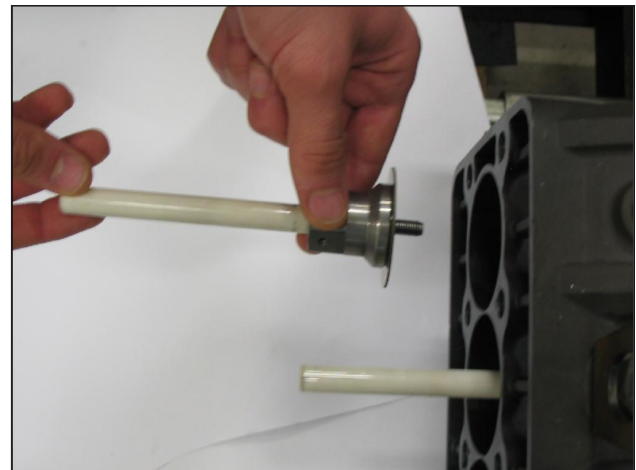

Fig. 29

- Déposer les éléments de pompage à l'aide d'une clé à fourchette et vérifier s'ils sont usés, comme le montrent les Fig. 28 et Fig. 29, les remplacer si nécessaire.

- Enlever les vis M6x40 de fixation du support chemise comme le montre la Fig. 30 et désassembler le support comme le montre la Fig. 31.



Fig. 30

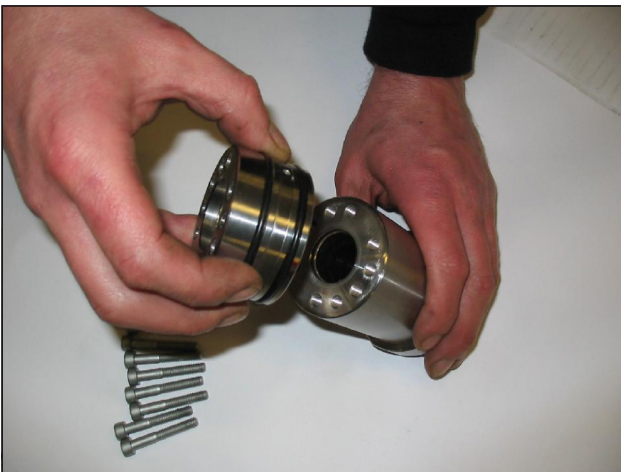

Fig. 31

- Déposer l'anneau seeger et l'anneau de retenue des joints d'étanchéité comme le montre la Fig. 32 et utiliser une goupille en plastique pour dégager le joint d'étanchéité LP (basse pression) ① comme le montre la Fig. 33.



Fig. 32

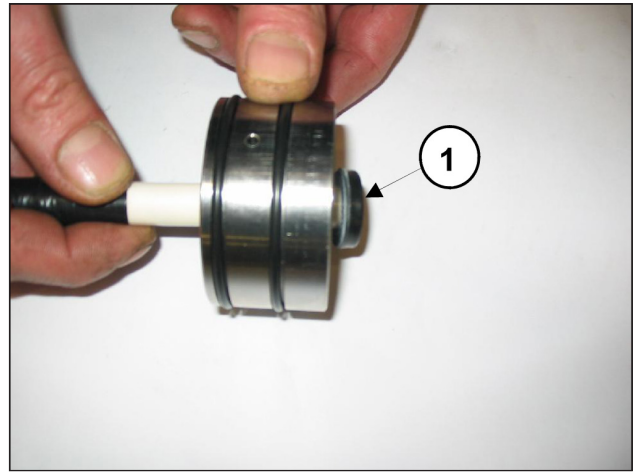

Fig. 33



Remplacer les joints d'étanchéité basse pression et les joints toriques à chaque opération de démontage.

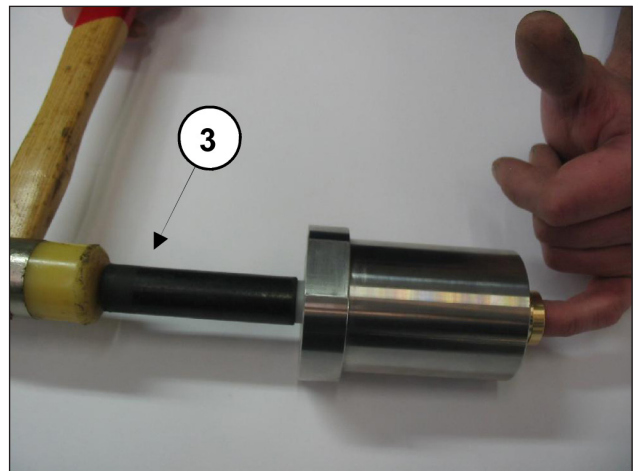

Fig. 34

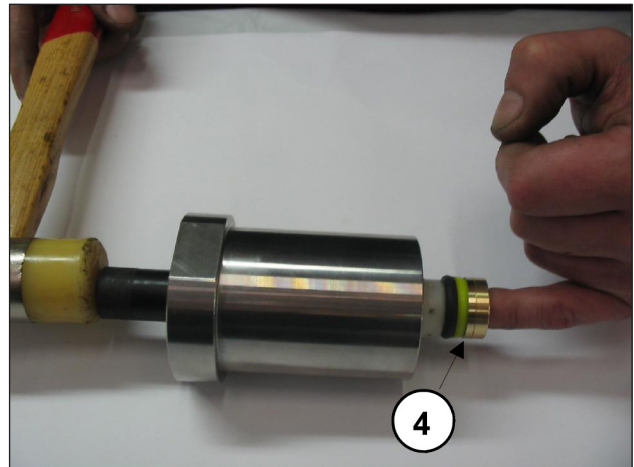

Fig. 35

- Chemise désassemblée du support des joints, utiliser une goupille en plastique ③ comme le montre la Fig. 34 pour chasser le lot HP (haute pression) ④ comme le montre la Fig. 35.



Remplacer le lot HP (Fig. 31, rep. ④) à chaque opération de démontage.

2.2.4 Remontage du groupe piston - supports - joints d'étanchéité

Pour le remontage des différents composants, inverser les opérations précédentes et faire particulièrement attention aux séquences décrites ci-après ; pour les valeurs des couples de serrage et les différents phases, respecter les indications figurant au chapitre 3.

- Insérer la douille supérieure dans la chemise.

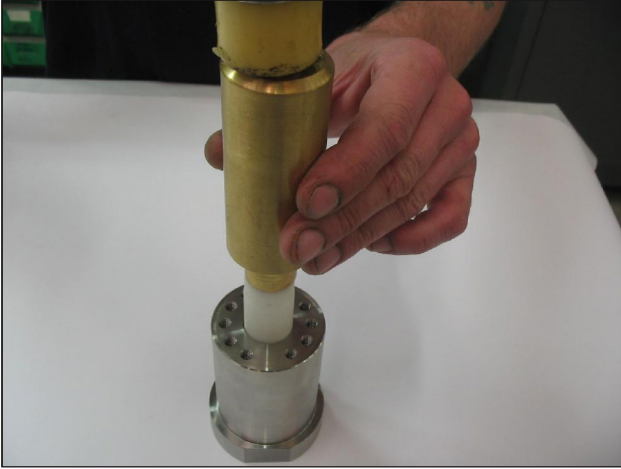

Fig. 36



Fig. 37



Pour installer correctement la douille en position axiale, utiliser l'outil (réf. 27508300 valable pour les pompes type VF12 et réf. 27508500 valable pour les pompes type VF14) comme le montrent les Fig. 36 et Fig. 37.



Fig. 38

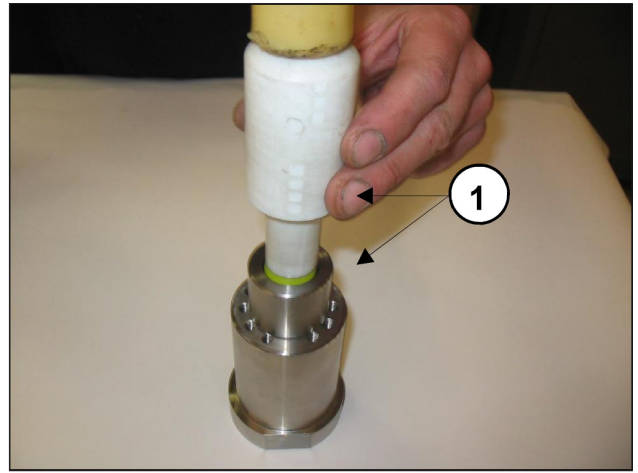

Fig. 39

- Introduire le lot H.P. (haute pression) ; vu la légère interférence entre le joint et la chemise, pour éviter tout dommage, il est conseillé d'utiliser l'outil indiqué Fig. 38 et Fig. 39 rep. ① (réf. 27508400 et réf. 27365300).

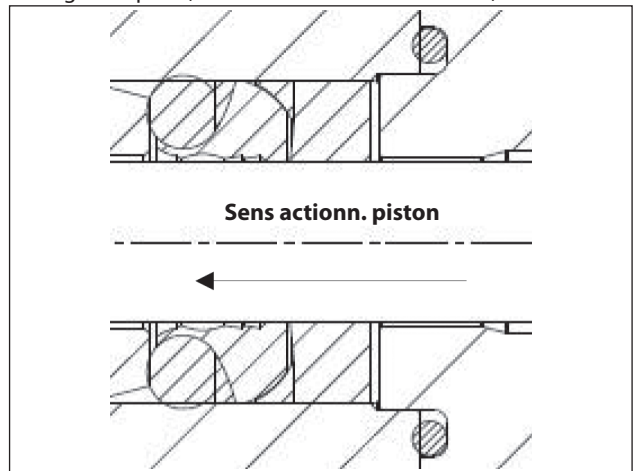

Fig. 40

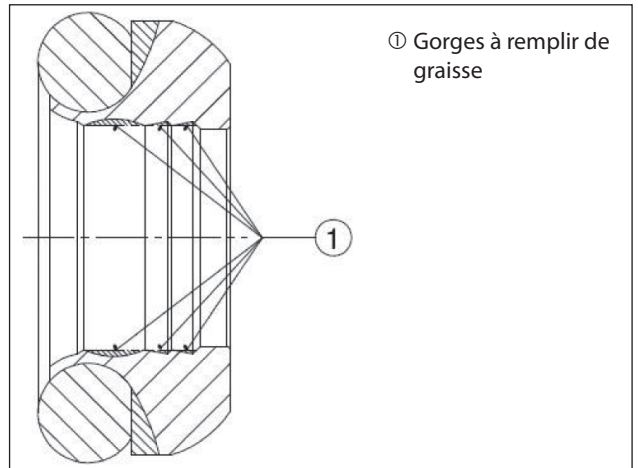

Fig. 40/a



Introduire le joint H.P. dans la chemise avec le joint torique énergisant, dans le sens d'actionnement du piston, comme le montrent les Fig. 38 et Fig. 40.



Avant de les remonter dans leur siège, lubrifier les joints H.P. avec de la graisse à base de silicone type OK S1110, en respectant les opérations ci-après :

- Ne lubrifier que très légèrement le diamètre extérieur ;
- En enduisant le diamètre intérieur, s'assurer de bien remplir les gorges comprises entre les lèvres d'étanchéité comme le montre la Fig. 40/a.

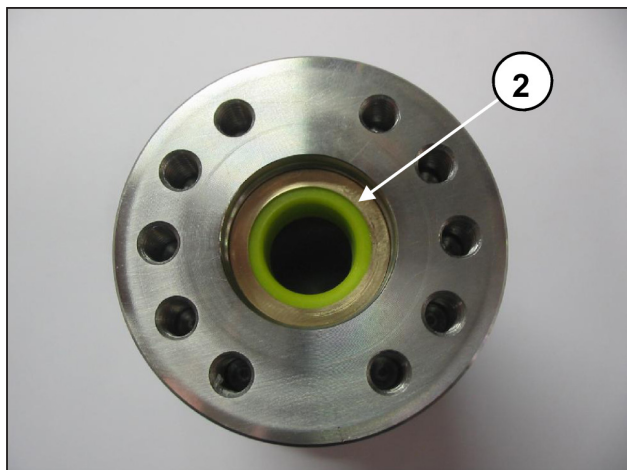

Fig. 41

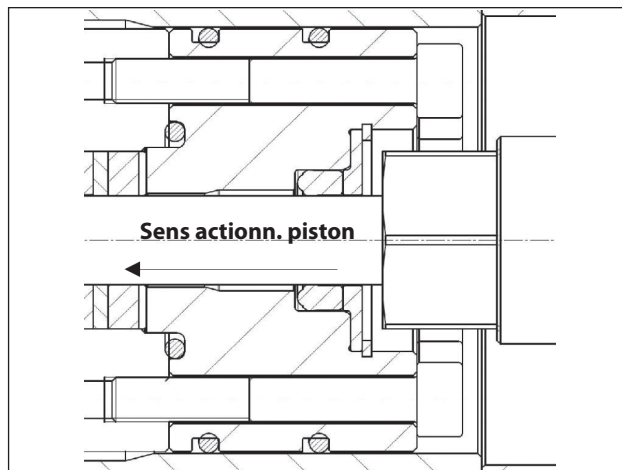

Fig. 44

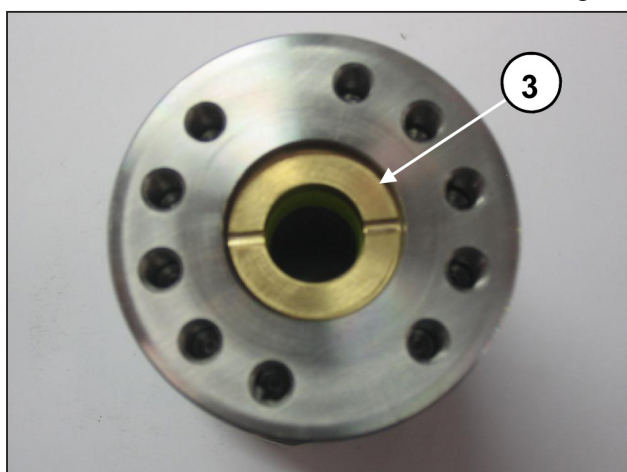

Fig. 42



Fig. 45

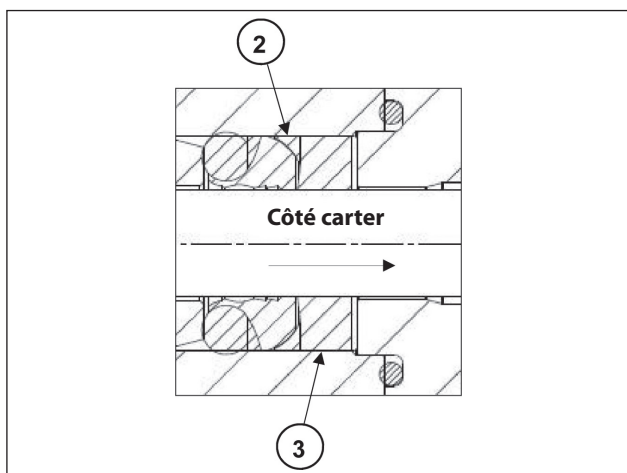

Fig. 43

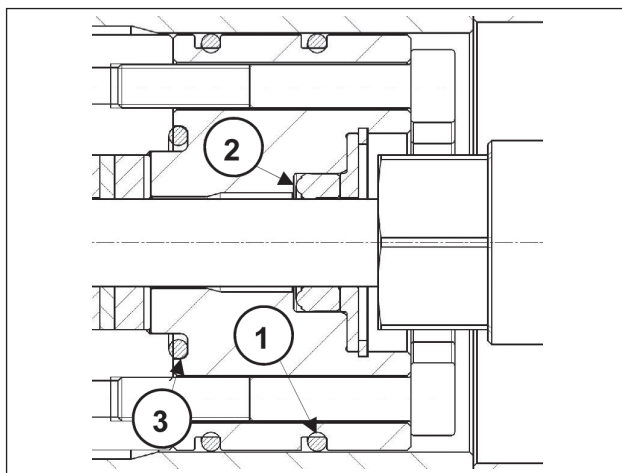

Fig. 46

- Introduire l'anneau anti-extrusion ② et la douille pour joints ③ en les positionnant comme le montrent les Fig. 41, Fig. 42, Fig. 43.



Introduire la douille pour joints ③ dans la chemise avec les orifices d'évacuation tournés vers l'extérieur (côté carter) comme le montrent les Fig. 42 et Fig. 43.



Introduire le joint L.P. dans la chemise avec la lèvres d'étanchéité dans le sens d'actionnement du piston, comme le montrent les Fig. 44 et Fig. 45, et lubrifier légèrement le diamètre extérieur avec de la graisse à base de silicone type OKS 1110.

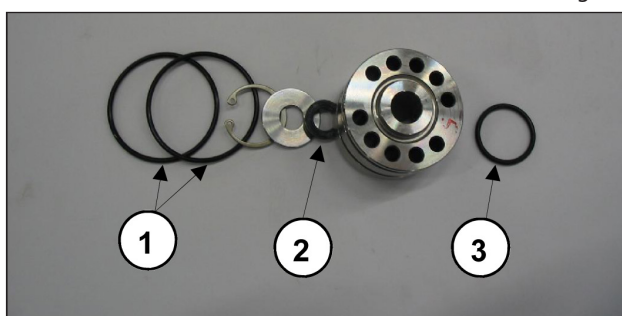

Fig. 47

- Remonter l'ensemble support des joints comme le montrent les Fig. 46 et Fig. 47 et remplacer les composants ① ② ③.



Fig. 48

- Assembler l'ensemble support - chemise en serrant manuellement les vis M6x40 comme le montre la Fig. 48. Procéder ensuite au réglage à l'aide d'une clé dynamométrique, en suivant les explications du chapitre 3.

3 FORCES DE SERRAGE DES VIS

Pour serrer les vis, utiliser exclusivement une clé dynamométrique.

Description	Rep. vue éclatée	Couple de serrage Nm
Vis de Fixation Couvertcles	9	10
Bouchon de vidange huile	11	40
Vis Fixation étrier de levage	17	40
Vis Fixation Chap. Bielle	16	30*
Fixation Pistons	28	20
Raccord d'étranglement	31	10
Vis Fixation supports	44	15****
Vis Fixation Tête	57	80**
Vis Fixation chemises	56	35***
Vis Flasque Mot. Hydraulique	64	40

* Les vis de fixation du chapeau de la bielle doivent être serrées en respectant les phases indiquées pag. 34.

** Les vis de fixation de la tête doivent être serrées en respectant les phases et l'ordre indiqué sur le schéma Fig. 50.

*** Les vis de fixation des chemises doivent être serrées en respectant les phases et l'ordre indiqué sur le schéma Fig. 50.

**** Les vis de fixation des supports doivent être serrées en une seule phase, en respectant l'ordre indiqué sur le schéma Fig. 49.

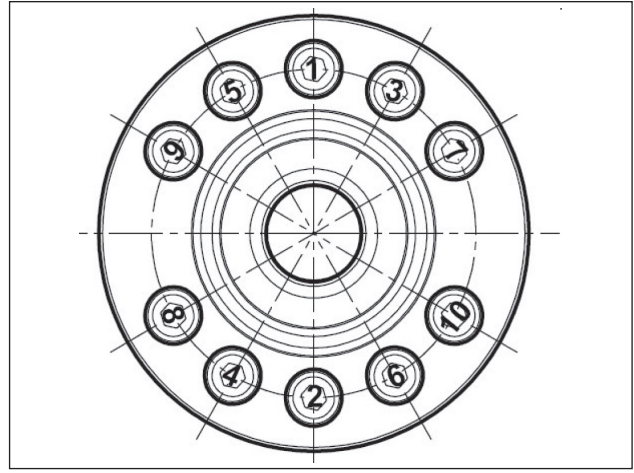

Fig. 49



Les vis - rep. 44-57 - doivent être serrées à l'aide d'une clé dynamométrique, en lubrifiant la tige filetée.

Serrage des vis de la tête et des chemises

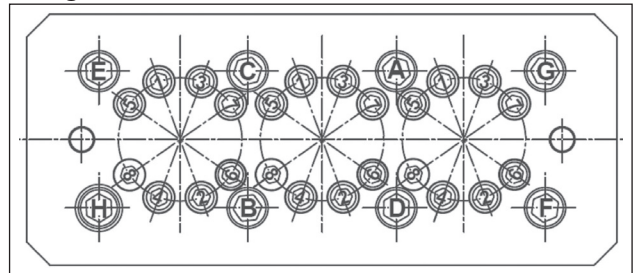

Fig. 50

OPÉRATION 1 : Serrage des vis M12x260 (rep. 56) en deux phases, en respectant la séquence indiquée sur la figure : (A-B-C-D-E-F-G-H)

Phase 1 = 40 Nm

Phase 2 = 80 Nm

OPÉRATION 2 : Serrage des vis M8x100 (rep. 57) en quatre phases, en respectant la séquence indiquée sur la figure : (1-2-3-4-5-6-7-8)

Phase 1 = 20 Nm

Phase 2 = 30 Nm

Phase 3 = 35 Nm

Phase 4 = 35 Nm

4 REMPLACEMENT DE LA DOUILLE PIED DE LA BIELLE

En phase d'entretien, s'il est nécessaire de remplacer la douille du pied de la bielle, suivre les indications suivantes :



Lors du retrait de la douille usagée, faire extrêmement attention à ne pas endommager ou rayer le siège sur la bielle.

Effectuer la fixation à froid de la nouvelle douille ; durant cette opération, s'assurer que :

- l'orifice de lubrification coïncide avec l'orifice correspondant présent sur la bielle ;
- l'incision de la jonction doit être orientée comme l'indique la Fig. 51.



Après quoi, procéder aux opérations mécaniques en respectant impérativement les dimensions et les tolérances indiquées Fig. 51.

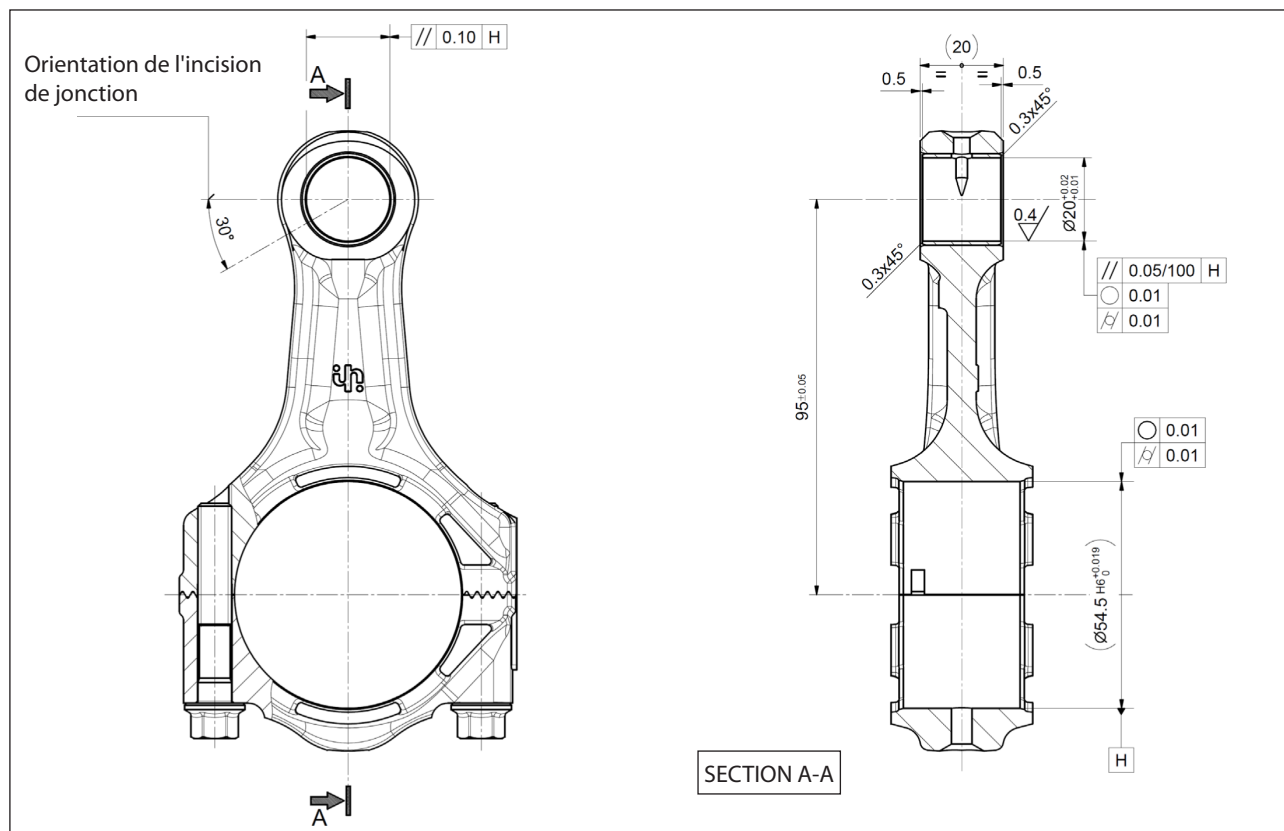

Fig. 51

5 OUTILS POUR LA RÉPARATION

La réparation de la pompe peut être facilitée si l'on utilise les outils appropriés codifiés ci-dessous :

Pour les phases de montage :

Douille pour joints VF12 ; Bague d'étanchéité alternative de H.P. Ø 12x24x13	réf. 27508400 réf. 27365300
Douille pour joints VF14 ; Bague d'étanchéité alternative de H.P. Ø 14x24x13	réf. 27508400 réf. 27365300
Colonne de montage tête (2 pièces)	réf. 27508200
Douille pour piston Ø12	réf. 27508300
Douille pour piston Ø14	réf. 27508500
Tampon pour joint d'huile d'arbre de pompe	réf. 27904800
Tampon pour joint d'huile guide du piston	réf. 27904900

Pour les phases de démontage :

Sièges de soupape VF12 - VF14	réf. 27508000
Colonne de montage tête (2 pièces)	réf. 27508200
Joint d'huile guide du piston	réf. 27503900 réf. 26019400

Inhaltsverzeichnis

1	EINLEITUNG	45
1.1	BESCHREIBUNG DER SYMBOLE.....	45
2	REPARATURVORSCHRIFTEN	45
2.1	REPARATUR DER MECHANIK	45
2.1.1	<i>Ausbau der Mechanik</i>	45
2.1.2	<i>Wiedereinbau der Mechanik</i>	47
2.1.3	<i>Vorgesehene Untermaßklassen</i>	49
2.1.4	<i>Ausbau/Wiedereinbau der Lager und Passscheiben</i>	49
2.2	REPARATUR DER HYDRAULIK.....	51
2.2.1	<i>Ausbau des Kopfs-Ventilgruppen</i>	51
2.2.2	<i>Wiedereinbau des Kopfs - Buchsen - Ventile</i>	53
2.2.3	<i>Ausbau der Kolbengruppe - Lager - Dichtungen</i>	53
2.2.4	<i>Wiedereinbau der Kolbengruppe - Lager - Dichtungen</i>	54
3	EICHWERTE FÜR DEN SCHRAUBENANZUG	57
4	AUSTAUSCH DER PLEUOLAUGENBUCHSE	58
5	REPARATURWERKZEUGE	58

1 EINLEITUNG

Diese Anleitung enthält die Anweisungen für die Reparatur der Pumpen der Baureihe VF und muss vor jeglichen Arbeiten an der Pumpe sorgfältig gelesen und verstanden werden. Der einwandfreie Betrieb und die lange Lebensdauer der Pumpe sind von der korrekten Verwendung und den angemessenen Wartungseingriffen abhängig. Interpump Group haftet nicht für Schäden durch Nachlässigkeit oder Nichtbeachtung der in dieser Anleitung beschriebenen Vorschriften.

1.1 BESCHREIBUNG DER SYMBOLE

Lesen Sie vor jeder Arbeit stets aufmerksam die Anweisungen in dieser Anleitung.



Warnzeichen



Lesen Sie vor jeder Arbeit stets aufmerksam die Anweisungen in dieser Anleitung.



Gefahrenzeichen
Schutzbrille tragen.



Gefahrenzeichen
Vor jeder Arbeit Schutzhandschuhe anziehen.

2 REPARATURVORSCHRIFTEN



2.1 REPARATUR DER MECHANIK

Vor den Reparaturarbeiten an der Mechanik muss zunächst das Öl aus dem Kurbelgehäuse abgelassen werden. Zum Ablassen des Öls müssen entfernt werden: der Ölmesstab Pos. ① und anschließend der Verschluss Pos. ②, Abb. 1 nach.



Abb. 1



Altöl muss in einem geeigneten Behälter gesammelt und den entsprechenden Wertstoffstellen zugeführt werden. Es darf auf keinen Fall in die Umwelt abgeleitet werden.

2.1.1 Ausbau der Mechanik

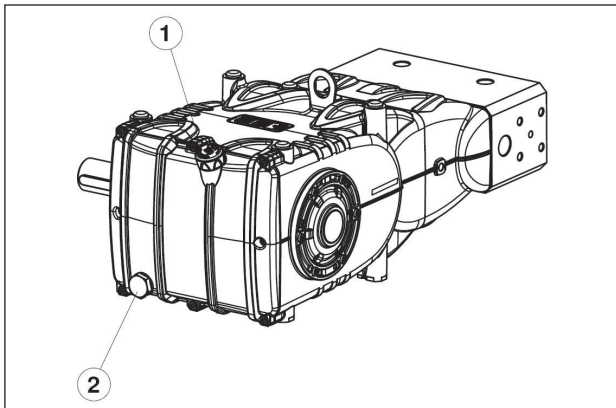
Vor Ausführung der hier beschriebenen Arbeiten müssen zunächst die Hydraulik, der Keramikkolben und der Spritzschutz von der Pumpe abgenommen werden (Abschn. 2.2.3, 2.2.4).

Die vorgeschriebene Arbeitsabfolge für den Ausbau lautet:

- die Passfeder von der Pumpenwelle
- der hintere Deckel
- der Pleueldeckel wie folgt: Lösen Sie die Befestigungsschrauben des Deckels, ziehen Sie die Pleueldeckel samt zugehörigen unteren Lagerschalen heraus (Abb. 2) und beachten Sie beim Ausbau die entsprechende nummerierte Reihenfolge.

Um Fehler zu vermeiden, sind Pleueldeckel und -schäfte auf einer Seite nummeriert (Abb. 2/a, Pos. ①).



Abb. 2



Abb. 2/a

- die seitlichen Deckel anhand von 3 Schrauben M6x50 mit Innengewinde als Abzieher, die in die Gewindebohrungen eingeführt werden gemäß Abb. 3.

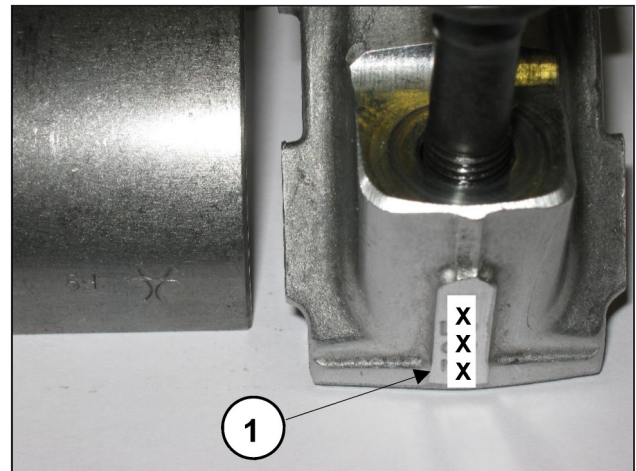

Abb. 3

- Schieben Sie die Pleuelführungen mit den entsprechenden Pleuelstangen nach vorn, um das seitliche Herausziehen der Pumpenwelle zu erleichtern. Die zwei Markierungen auf der Welle (mit 1 in Abb. 4 und Abb. 4/a angegeben) müssen zwecks leichter Entnahme zum Bediener ausgerichtet sein.



Abb. 4

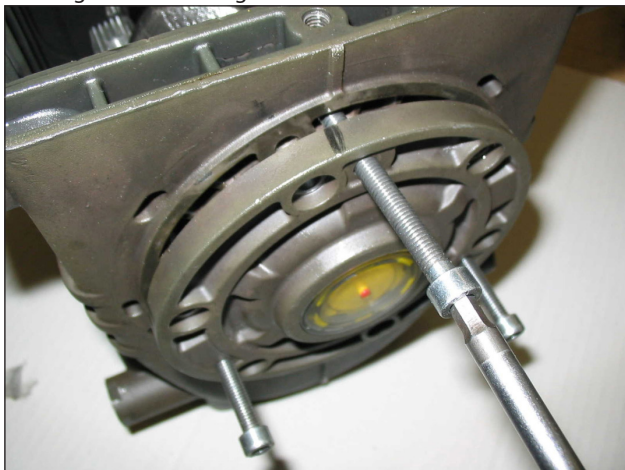

Abb. 4/a

- Ziehen Sie Pumpenwelle heraus
- Beenden Sie den Ausbau der Pleuelgruppen, indem Sie diese aus dem Pumpengehäuse herausziehen und die Pleuelbolzen von den Pleuelführungen abnehmen.
- Entfernen Sie die Dichtringe der Pumpenwelle mit gängigen Werkzeugen.
- Entfernen Sie die Dichtringe der Pleuelführungen wie folgt:

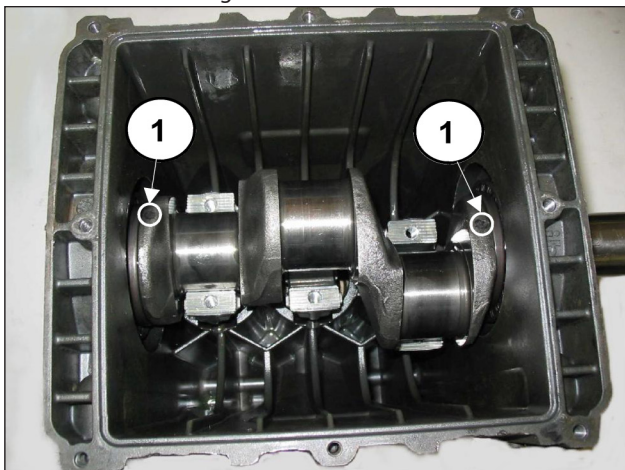
Verwenden Sie den Abzieher Art. 26019400 (Abb. 5, Pos. ①) und die Zange Art. 27503900 (Abb. 5, Pos. ②). Setzen Sie die Zange mithilfe eines Hammers (Abb. 5/a) bündig auf den Dichtring ein, schrauben Sie dann den Abzieher an die Zange und betätigen Sie das Schlagwerk des Abziehers (Abb. 5/b) bis zum Herausziehen des zu ersetzenden Rings (Abb. 5/c).

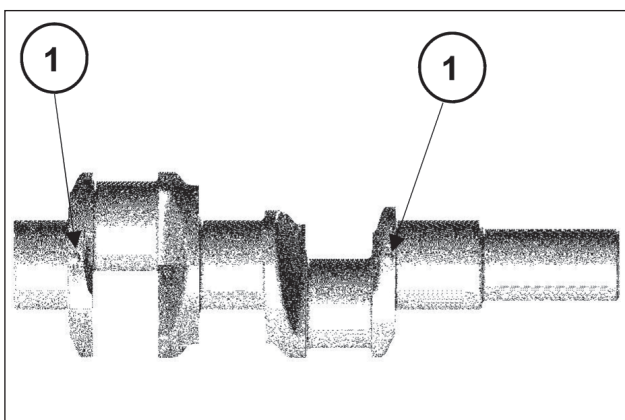

Abb. 5



Abb. 5/a

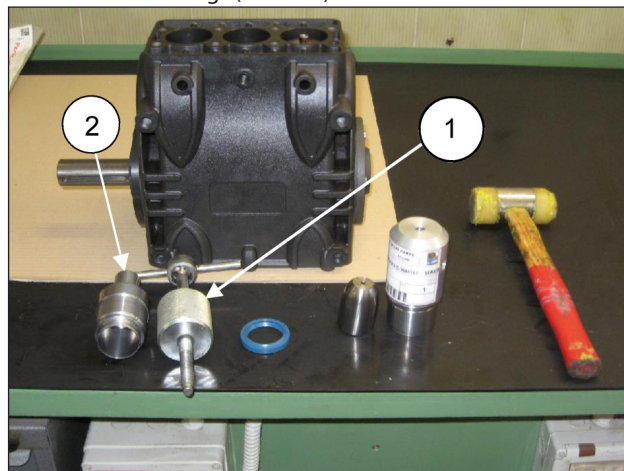

Abb. 5/b



Abb. 5/c

2.1.2 Wiedereinbau der Mechanik

Nachdem Sie das Gehäuse auf seine Sauberkeit überprüft haben, können Sie die Mechanik folgendermaßen wieder einbauen:

- Montieren Sie die oberen und unteren Lagerschalen in ihre jeweiligen Sitze an Pleuelstangen und -deckeln.



Stellen Sie sicher, dass die Bezugsmarken der oberen (Abb. 6, Pos. ①) und unteren Lagerschalen (Abb. 6/a, Pos. ②) in die entsprechende Sitze der Pleuelstange und des Pleueldeckels eingesetzt werden.



Abb. 6



Abb. 6/a

- Führen Sie die Baugruppen Kolbenführungen / Pleuelstange so in das Pumpengehäuse ein, dass die Nummerierung am Pleuelschaft zur Oberseite des Gehäuses ausgerichtet ist.

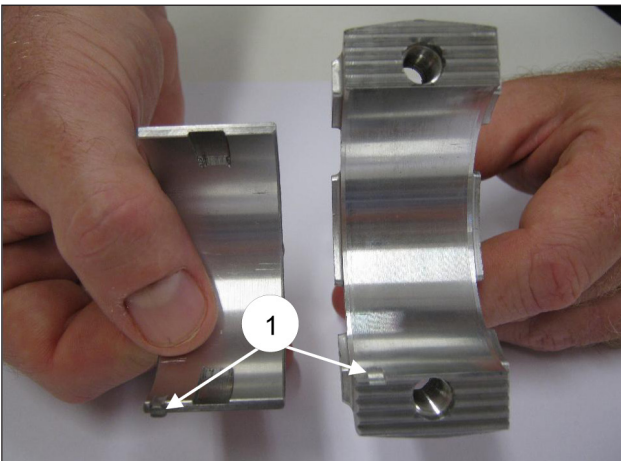
Um das Einsetzen der Pumpenwelle (ohne Passfeder) zu erleichtern, müssen Sie den beim Ausbau durchgeführten Vorgang wiederholen und hierbei die Baugruppen Kolbenführungen / Pleuelstange bis auf Anschlag einschieben (Abschn. 2.1.1).

- Prüfen Sie vor der Montage des Deckels auf Zapfwellenseite den Zustand der Dichtlippe des radialen Dichtrings sowie den entsprechenden Kontaktbereich an der Welle.

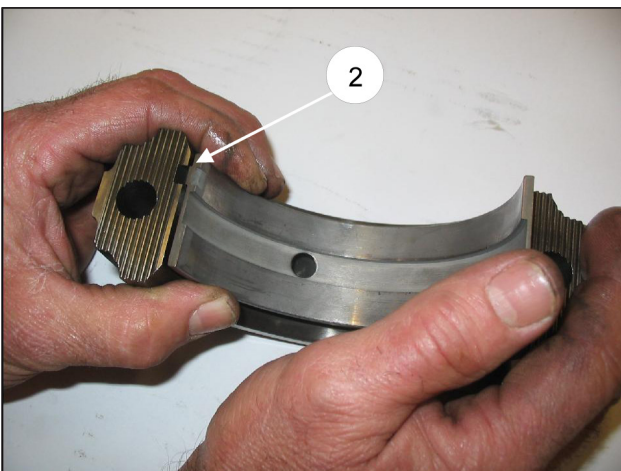
Im Fall eines Austauschs setzen Sie den neuen Ring mithilfe des Werkzeugs (Art. 27904800) gemäß Abb. 7 ein.



Sollte die Pumpenwelle im Kontaktbereich mit der Dichtlippe einen Verschleiß am Durchmesser aufweisen, können Sie zur Vermeidung der Schleifbearbeitung den Ring auf Anschlag mit dem Deckel neu ausrichten, siehe hierzu Abb. 7.

Stellen Sie vor dem Einbau der Seitendeckel sicher, dass an beiden Deckeln die O-Ringe und am Deckel auf Seite des Schauglases die Passringe vorhanden sind.

Um das Einführen des ersten Abschnitts und das Einsetzen der Deckel am Gehäuse zu erleichtern, sollten Sie 3 Schrauben M6 x 40 mit Teilgewinde (Abb. 8, Pos. ①) zu Hilfe nehmen und den Vorgang dann anhand der mitgelieferten Schrauben (M6x18) abschließen.



Abb. 7



Abb. 8

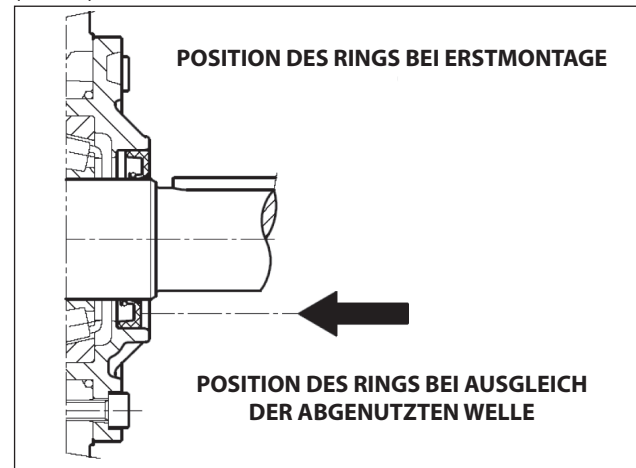

- Paaren Sie die Pleueldeckel unter Berücksichtigung der Nummerierung mit den zugehörigen Schäften (Abb. 9, Pos. ①).

Achten Sie auf den richtigen Einbausinn der Lagerdeckel.

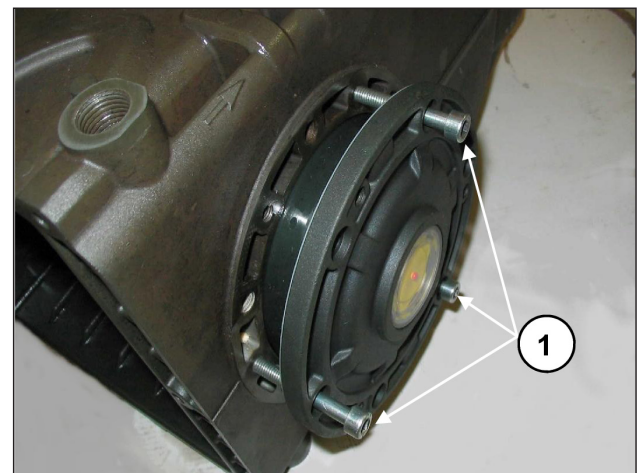

Abb. 9

- Befestigen Sie die Pleueldeckel an den entsprechenden Pleuelschäften mit den Schrauben M8x1x48 (Abb. 10) und schmieren Sie sowohl den Bereich unter dem Kopf als auch den Gewindeschaft in zwei verschiedenen Schritten:



1. **Drehen Sie die Schrauben von Hand bis zum beginnenden Festsitz an**
 2. **Anzugsmoment** **30 Nm**
- Alternative Möglichkeit:**
1. **Vorläufiges Anzugsmoment** **10-15 Nm**
 2. **Anzugsmoment** **30 Nm**

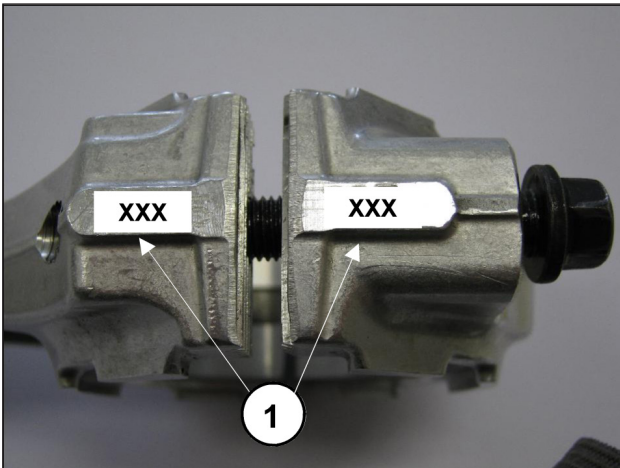

Abb. 10

- Überprüfen Sie nach Anziehen der Schrauben, ob der Kopf der Pleuelstange ein Seitenspiel in beiden Richtungen aufweist.
- Setzen Sie die neuen Dichtringe der Kolbenführungen bis auf Anschlag in den entsprechenden Sitz am Pumpengehäuse (Abb. 11) folgendermaßen ein:

Verwenden Sie das Werkzeug Art. 27904900 bestehend aus Kegelbuchse und Dorn. Drehen Sie die Kegelbuchse in die Bohrung an der Kolbenführung ein (Abb. 11/a), setzen Sie den neuen Dichtring auf den Dorn und bis auf Anschlag (von der Höhe des Dorns abhängig) in seinen Sitz am Pumpengehäuse ein (Abb. 11/b), nehmen Sie dann die Kegelbuchse ab (Abb. 11/c).



Abb. 11



Abb. 11/a

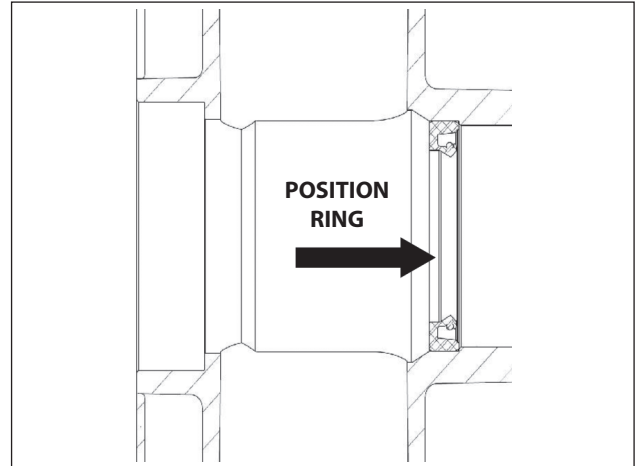

Abb. 11/b



Abb. 11/c

- Setzen Sie den hinteren Deckel samt O-Ring so ein, dass die Bohrung des Ölmesstabs nach oben zeigt.
- Füllen Sie Öl in das Gehäuse gemäß Angaben in der **Betriebs- und Wartungsanleitung**.

2.1.3 Vorgesehene Untermaßklassen

UNTERMASSTABELLE FÜR KURBELWELLE UND PLEUEL-LAGERSCHALEN			
Ausgleichklassen (mm)	Art. obere Lagerschale	Art. untere Lagerschale	Schliff am Durchmesser des Wellenzapfens (mm)
0.25	90924100	90924400	Ø49.75 0/-0.02 Ra 0.4 Rt 3.5
0.50	90924200	90824500	Ø49.50 0/-0.02 Ra 0.4 Rt 3.5

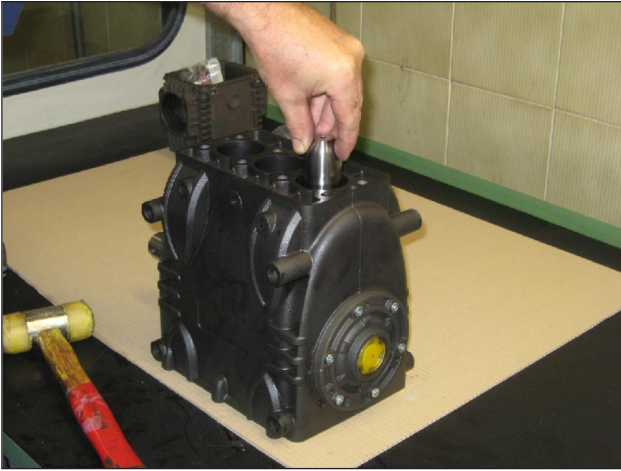
2.1.4 Ausbau/Wiedereinbau der Lager und Passscheiben

Die Art der Lager (Kegelrollenlager) garantiert, dass die Kurbelwelle kein Axialspiel aufweist. Zu diesem Zweck müssen Passscheiben festgelegt werden. Für den Ausbau / Wiedereinbau und den etwaige Austausch müssen Sie folgende Anweisungen unbedingt befolgen:

A) Ausbau / Wiedereinbau der Kurbelwelle ohne Austausch der Lager

Nach Abnahme der seitlichen Deckel, vgl. Abschn. 2.1.1, überprüfen Sie den Zustand der Rollen und der entsprechenden Bahnen; wenn alle Teile fehlerfrei sind, reinigen Sie diese gründlich mit einem geeigneten Entfettungsmittel und tragen Sie anschließend wieder gleichmäßig Schmieröl auf.

Sie können die alten Passscheiben wiederverwenden und achten Sie darauf, diese unter den Deckel auf Schauglasseite einzusetzen.

Prüfen Sie nach Einbau der kompletten Gruppe (Flansch auf Schauglasseite + Welle + Flansch auf Motorseite) und nach Festziehen der Deckelschrauben mit dem vorgeschriebenen Anzugsmoment, dass das Reibmoment der Welle bei nicht verbundenen Pleueln in einem Bereich zwischen 4 und 6 Nm liegt.

Für das Annähern der beiden Seitendeckel an das Gehäuse können Sie zunächst 3 Schrauben M6x40 für eine erste Ausrichtung verwenden, wie im Vorhinein angegeben, und dann die für die endgültige Befestigung vorgesehenen Schrauben.

Das Reibmoment der Welle bei verbundenen Pleueln darf 8 Nm nicht übersteigen.

B) Ausbau / Wiedereinbau der Kurbelwelle mit Austausch der Lager

Nach Ausbau der Seitendeckel gemäß vorstehenden Angaben entfernen Sie den äußeren Lagerring von den entsprechenden Aufnahmen an den Deckeln mithilfe eines geeigneten Abziehers, siehe Abb. 12 und Abb. 12/a.

Nehmen Sie den inneren Ring von den beiden Wellenenden mit einem geeigneten Abzieher oder alternativ mit einem einfachen "Austreiber" ab, siehe Abb. 13.



Abb. 12



Abb. 12/a

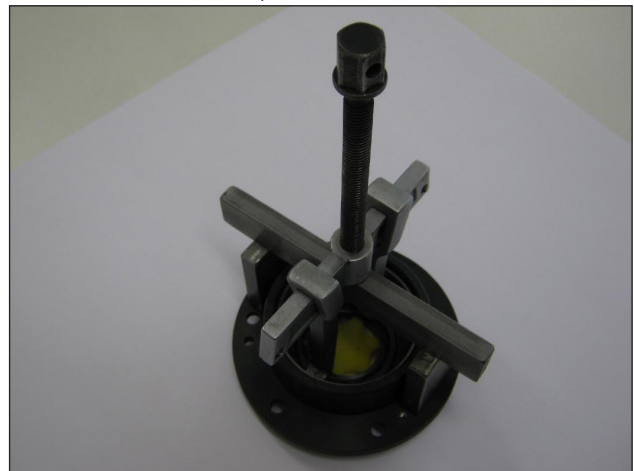

Abb. 13

Die neuen Lager können kalt mit einer Presse oder einer Traverse montiert werden, wobei sie unbedingt auf der Seitenfläche der betreffenden Ringe an der Setzfläche mit den jeweiligen Ringen aufliegen müssen. Das Setzen kann durch Erhitzen der betroffenen Teile auf eine Temperatur von 120° - 150°C (250° - 300°F) erleichtert werden. Stellen Sie dabei sicher, dass die Ringe bündig in ihre Sitze eingesetzt werden.

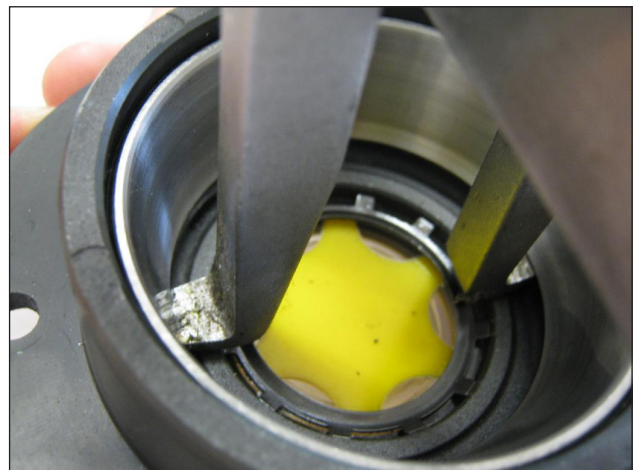

Vertauschen Sie niemals die Teile der beiden Lage.

Bestimmung des Passscheibenpakets:

Führen Sie diesen Vorgang bei montierten Baugruppen Kolbenführungen-Pleuelstangen, abgenommenen Pleueldeckeln und nach unten geschobenen Pleuelstangen aus. Setzen Sie die Pumpen ohne Passfeder in das Gehäuse sein und stellen Sie sicher, dass der Zapfwellenstummel auf der gewünschten Seite austritt.

Befestigen Sie gemäß dem vorgenannten Verfahren den Flansch auf Zapfwellenseite am Gehäuse und achten Sie besonders auf die Lippe des Dichtrings. Ziehen Sie dann die Befestigungsschrauben auf das vorgeschriebene Anzugsmoment fest.

Führen Sie anschließend den Flansch auf Schauglasseite ohne Passscheiben in das Gehäuse ein. Beginnen Sie mit dem Annähern, indem Sie die Wartungsschrauben M6x40 gleichmäßig von Hand mit kleinen Drehungen eindrehen, um den Deckel langsam und korrekt vorwärts zu bewegen. Überprüfen Sie gleichzeitig durch manuelles Drehen die freigängige Wellendrehung.

Wenn Sie den Vorgang auf diese Weise fortsetzen, spüren Sie an einer bestimmten Stelle, dass plötzlich die Drehbewegung der Welle schwergängiger wird.

Unterbrechen Sie nun die Vorwärtsbewegung des Deckels und lösen Sie die Befestigungsschrauben vollständig. Messen Sie mit einer Fühlerlehre das Spiel zwischen Seitendeckel und Pumpengehäuse (siehe Abb. 14).



Abb. 14

Bestimmen Sie nun das Passscheibenpaket anhand folgender Tabelle:

Messwert	Typ der Passscheibe	Stückzahl
Von: 0,05 bis: 0,10	/	/
Von: 0,11 bis: 0,20	0,1	1
Von: 0,21 bis: 0,30	0,1	2
Von: 0,31 bis: 0,35	0,25	1
Von: 0,36 bis: 0,45	0,35	1
Von: 0,46 bis: 0,55	0,35 0,10	1 1
Von: 0,56 bis: 0,60	0,25	2
Von: 0,61 bis: 0,70	0,35 0,25	1 1



Abb. 15

Nachdem Sie Typ und Anzahl der Passscheiben lt. Tabelle festgelegt haben, führen Sie folgende Kontrolle aus: Montieren Sie das Passscheibenpaket an der Zentrierung des Deckels auf Schauglasseite (Abb. 15), befestigen Sie den Deckel am Gehäuse gemäß Angaben in Abschn. 2.1.2 und ziehen Sie die entsprechenden Schrauben mit dem vorgeschriebenen Anzugsmoment fest. Stellen Sie sicher, dass das Rollreibungsmoment der Welle in einem Bereich zwischen 4 und 6 Nm liegt. Ist dieses Drehmoment korrekt, fahren Sie mit dem Anschluss der Pleuelstangen an der Kurbelwelle und den weiteren Schritten fort. Andernfalls wiederholen Sie die vorgenannten Verfahren und legen Sie ein neues Passscheibenpaket fest.

2.2 REPARATUR DER HYDRAULIK

2.2.1 Ausbau des Kopfs-Ventilgruppen

Der Kopf bedarf keiner regelmäßigen Wartung. Die Arbeiten beschränken sich auf die Inspektion oder den Austausch der Ventile im Bedarfsfall.

Verfahren Sie zur Abnahme der Ventilgruppen wie folgt:



Abb. 16



- Lockern Sie die Befestigungsschrauben M8x100 der Buchsen am Kopf gemäß Abb. 16, um die Ventilgruppen freizugeben.

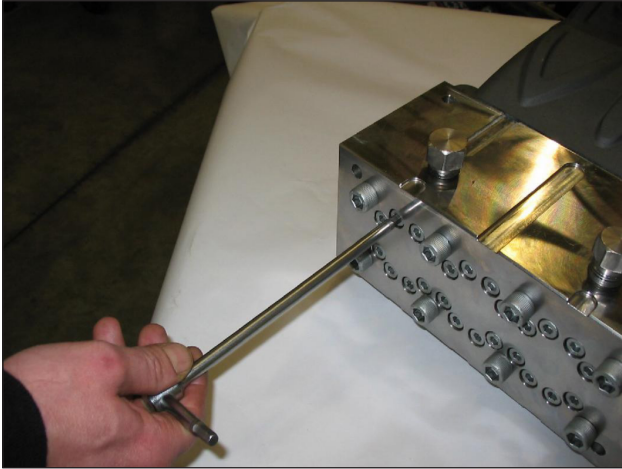

Abb. 17



Abb. 18

- Lösen Sie die Befestigungsschrauben des Kopfs M12x260 Pos. 5 und Pos. 6 wie in Abb. 17 gezeigt und ersetzen Sie diese durch zwei Wartungsschrauben - Stifte (Art. 27508200) gemäß Abb. 18. Nehmen Sie dann die übrigen Schrauben ab.

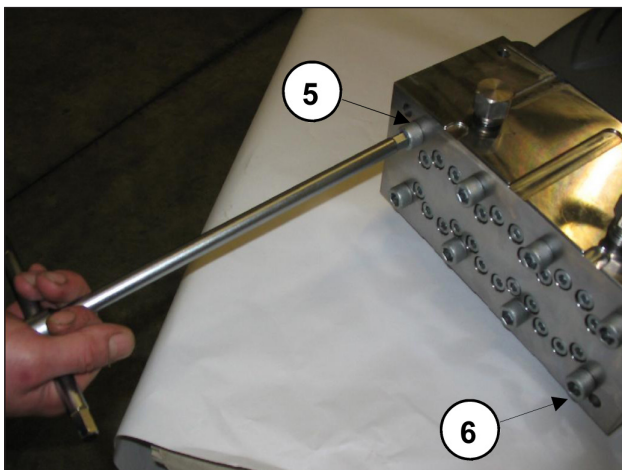

Abb. 19

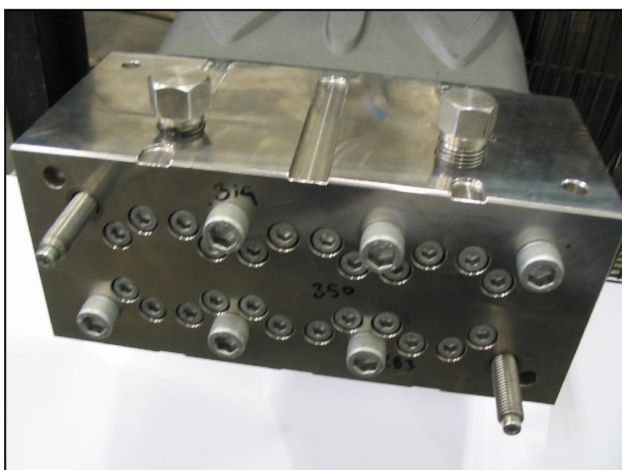

Abb. 20

- Trennen Sie den Kopf und das Distanzstück der Buchsen vom Pumpengehäuse gemäß den Hinweisen in Abb. 19 und Abb. 20.



Abb. 21

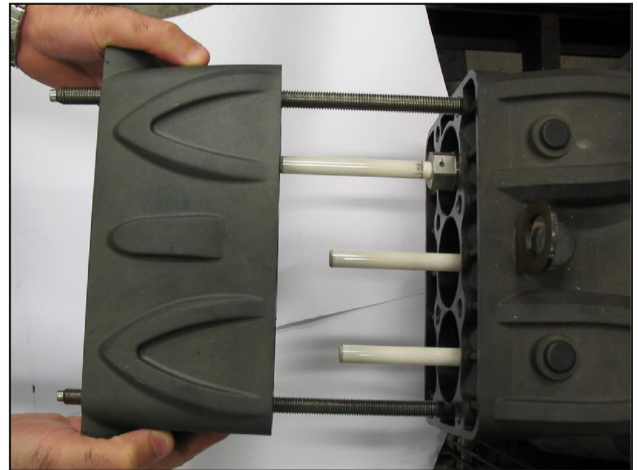

Abb. 22

- Lösen Sie die Befestigungsschrauben M8x100 der Buchsen am Kopf wie in Abb. 21 gezeigt und gehen Sie dann gemäß Abb. 22 vor.



Abb. 23

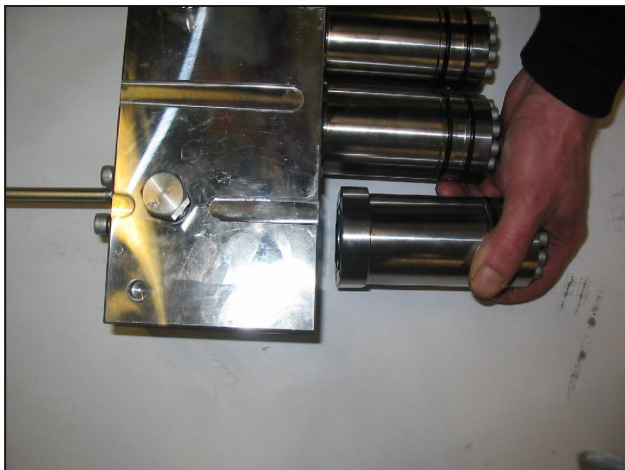

Achten Sie beim Ausbau der Buchsen darauf, nicht die Ventilsitze ① und die Flachventile ② wie in Abb. 23 gezeigt zu verlieren, da diese nur bündig eingesetzt sind und dadurch herausfallen können.

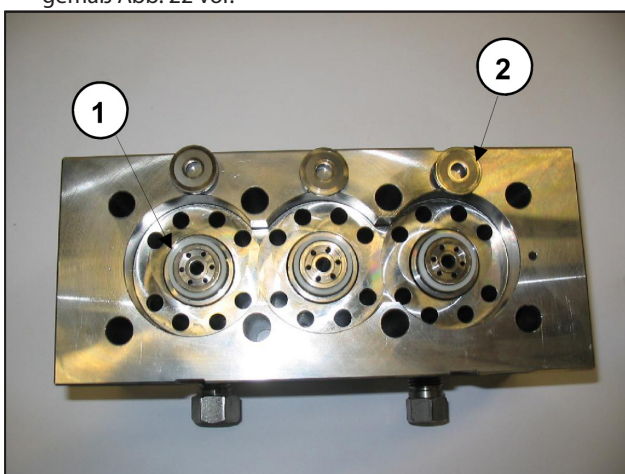

Abb. 24



Lösen Sie die ggf. durch Kalk oder Oxid am Kopf verklemmten Ventilsitze, indem Sie das entsprechende Werkzeug (Art. 27508000 "VF12" - "VF14") gemäß Abb. 24 in die Saugbohrung einsetzen.

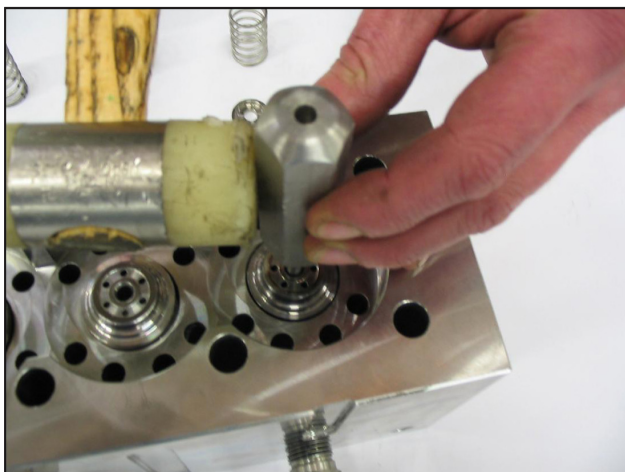

Abb. 25

- Entnehmen Sie die Ventilsitze ① wie in Abb. 25 dargestellt, überprüfen Sie den Verschleißzustand der einzelnen Bauteile und tauschen Sie diese bei Bedarf aus.

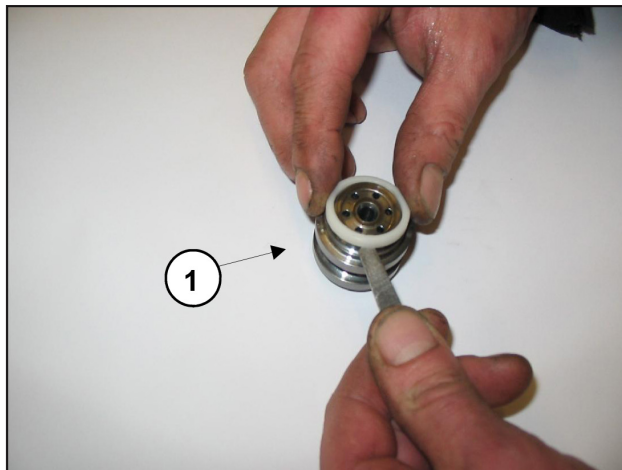

Ersetzen Sie bei jeder Ventilinspektion stets alle Dichtringe und die zugehörigen O-Ringe für die stirnseitige Abdichtung zwischen Buchse und Kopf und zwischen Kopf und Distanzstück im Bereich der Umlaufbohrung.

Reinigen und trocknen Sie vor dem Wiedereinbau die einzelnen Bauteile und sämtliche Aufnahmen im Kopf.



Abb. 26



Abb. 27

- Ziehen Sie die Teller der Druckventile ③ und die jeweiligen Führungen ④ samt Federn lt. Abb. 26 und Abb. 27 heraus, überprüfen Sie ihren Verschleißzustand und nehmen Sie den Austausch bei Bedarf und auf jeden Fall in den Intervallen der Tabelle "VORBEUGENDE WARTUNG" in Kapitel 11 der **Betriebs- und Wartungsanleitung** vor.

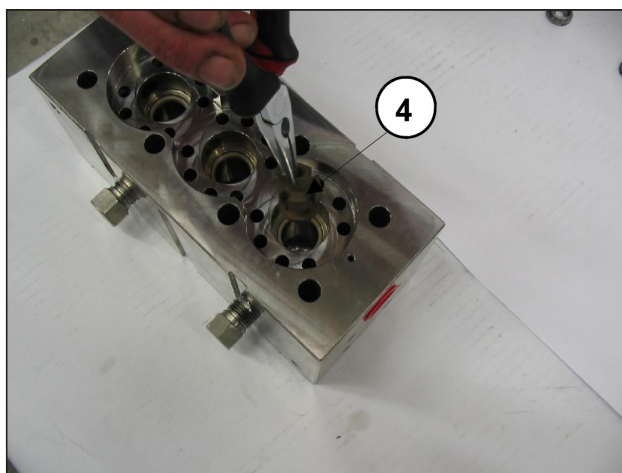
2.2.2 Wiedereinbau des Kopfs - Buchsen - Ventile

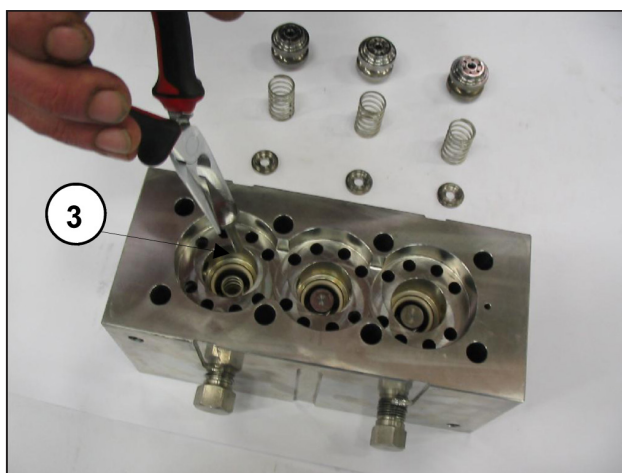

Führen Sie zum Wiedereinbau der einzelnen Bauteile die vorgenannten Arbeiten in umgekehrter Reihenfolge aus und achten Sie auf den vorschriftsmäßigen Einbau des Distanzstücks für Buchsen: die zwei unbearbeiteten Aussparungen an einer der beiden Seiten müssen bei eingebautem Teil zur unteren Gehäuseseite ausgerichtet sein (Befestigungsseite der Pumpe).

Köpfe - Buchsen: Montieren und eichen Sie die Befestigungsschrauben des Kopfs und eichen Sie dann die Befestigungsschrauben der Buchsen.

Für die Anzugsmomente und die verschiedenen Phasen beachten Sie die Angaben in Kapitel 3.

2.2.3 Ausbau der Kolbengruppe - Lager - Dichtungen

Die Kolbenbaugruppe bedarf keiner regelmäßigen Wartung. Die Eingriffe beschränken sich lediglich auf die Sichtinspektion des Kühlkreis-Ablasses. Sollten Störungen / Schwingungen am Druckmanometer oder Pulsationen in der Ablassleitung (Schlauch) des Kühlkreises auftreten, muss das Dichtungspaket überprüft und ggf. ausgetauscht werden. Verfahren Sie zur Abnahme der Kolbenbaugruppen wie folgt.

- Trennen Sie den Kopf und das Distanzstück der Buchsen vom Pumpengehäuse gemäß den Hinweisen in Abschn. 2.2.1 (Abb. 19, Abb. 20).



Abb. 28



Abb. 29

- Entfernen Sie die Pumpenelemente mit einem Gabelschlüssel, überprüfen Sie ihren Verschleißzustand, wie in Abb. 28 und Abb. 29 angegeben, und ersetzen Sie diese bei Bedarf.
- Lösen Sie die Befestigungsschrauben M6x40 des Halters an der Buchse wie in Abb. 30 gezeigt und bauen Sie dann den Halter gemäß Abb. 31 aus.

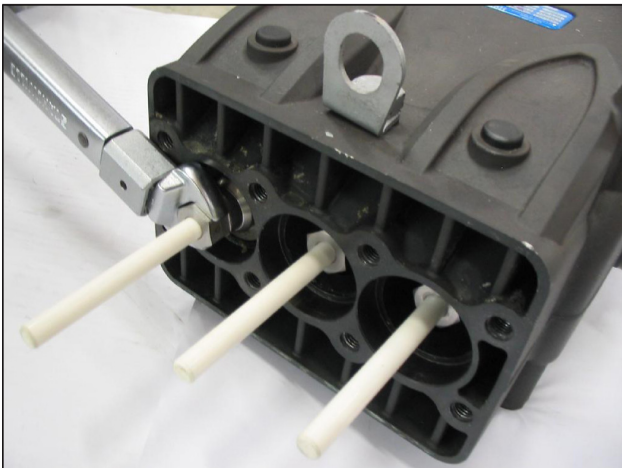

Abb. 30

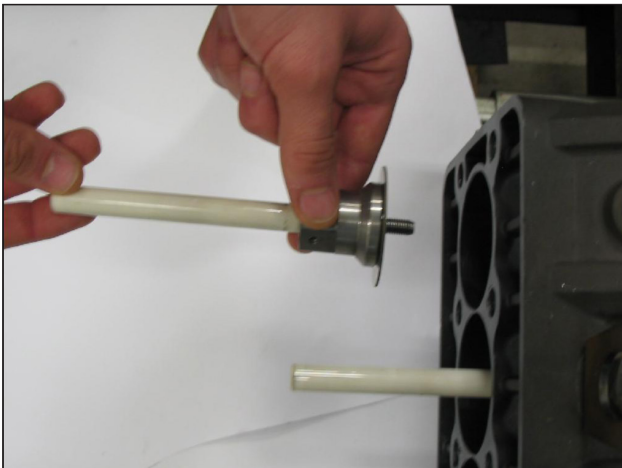

Abb. 31

- Entfernen Sie den Seegerring und den Sicherungsring der Dichtungen gemäß Abb. 32 und ziehen Sie mit einem speziellen Kunststoffdorn den ND (Niederdruck) Dichtring ① gemäß Abb. 33 ab.



Abb. 32

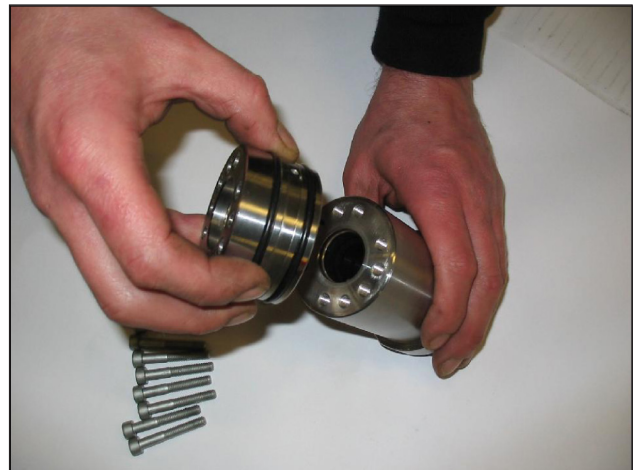

Abb. 33



Bei jedem Ausbau müssen sowohl die ND-Dichtringe als auch sämtliche O-Ringe ersetzt werden.

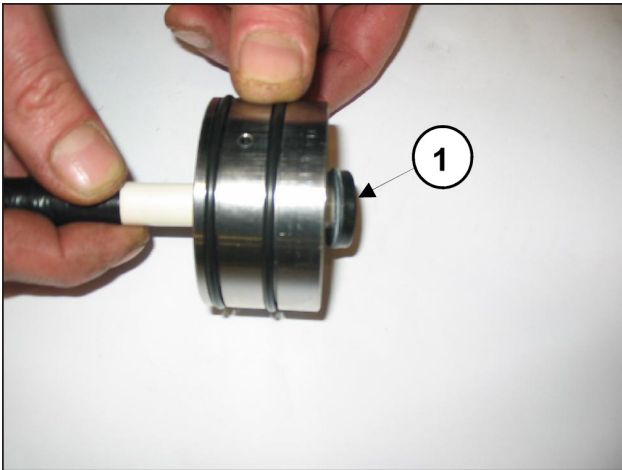

Abb. 34



Abb. 35

- Ziehen Sie nach Trennung der Buchse vom Dichtungshalter mit einem speziellen Kunststoffdorn ③ gemäß Abb. 34 den HD (Hochdruck) Dichtungssatz ④ wie in Abb. 35 heraus.

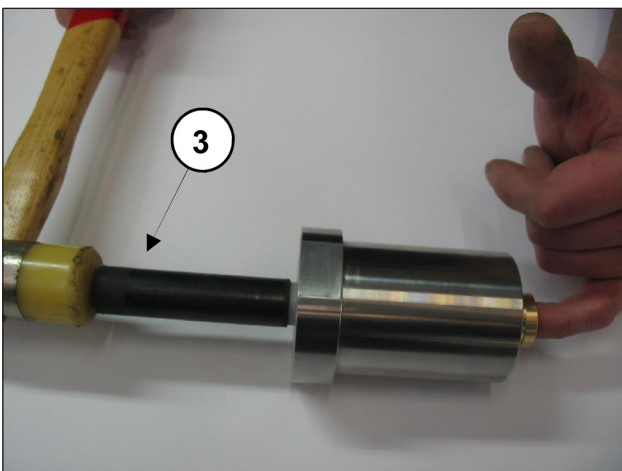

Bei jedem Ausbau muss der HD-Dichtungssatz (Abb. 31, Pos. ④) ausgetauscht werden.

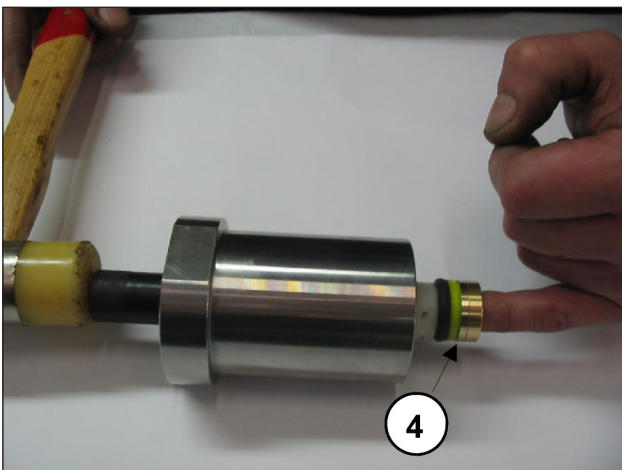
2.2.4 Wiedereinbau der Kolbengruppe - Lager - Dichtungen

Führen Sie zum Wiedereinbau der einzelnen Bauteile die vorgenannten Schritte in umgekehrter Reihenfolge aus und achten Sie dabei auf die einzelnen Abfolgen, wie im Nachhinein geschildert. Für die Anzugsmomente und die verschiedenen Phasen beachten Sie die Angaben in Kapitel 3.

- Führen Sie die obere Hülse in die Buchse ein.



Abb. 36



Abb. 37



Verwenden Sie für die korrekte axiale Ausrichtung das entsprechende Werkzeug (Art. 27508300 für Pumpen Typ VF12 und Art. 27508500 für Pumpen Typ VF14) wie in Abb. 36 und Abb. 37 gezeigt.



Abb. 38



Abb. 39

- Setzen Sie das HD-Dichtungspaket (Hochdruck) ein; verwenden Sie aufgrund des leichten Übermaßes zwischen Dichtung und Buchse zur Vermeidung von Schäden das Werkzeug in Abb. 38 und Abb. 39 Pos. ① (Art. 27508400 und Art. 27365300).



Abb. 40

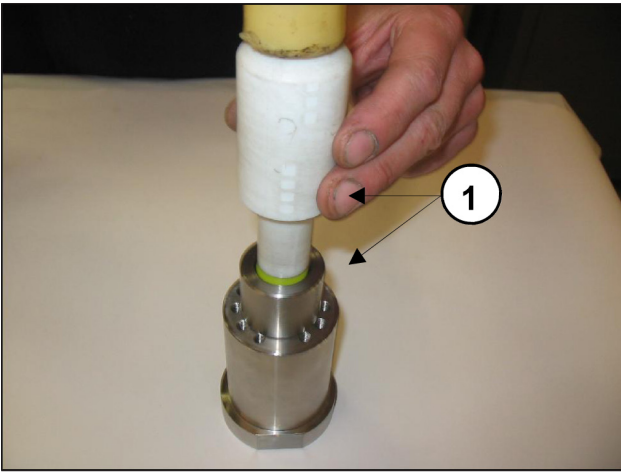

Abb. 40/a

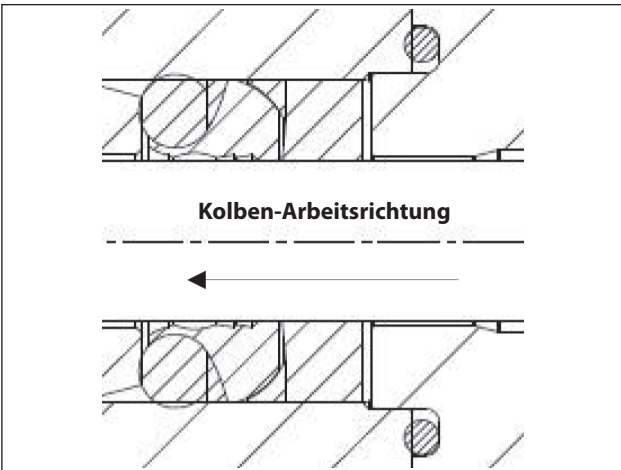

Die HD-Dichtung muss mit vorgespanntem O-Ring in Arbeitsrichtung des Kolbens in die Buchse eingesetzt werden, siehe Abb. 38 und Abb. 40.

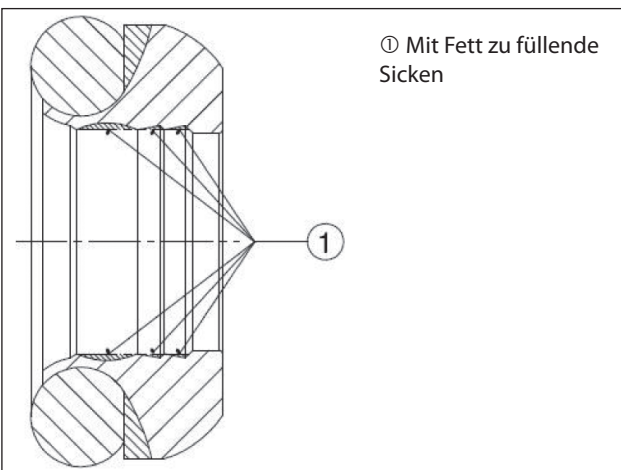

Vor dem Einsetzen müssen die HD-Dichtungen mit Silikonfett der Sorte OK S1110 wie folgt geschmiert werden:

- Schmieren Sie den Außendurchmesser nur leicht ein;
- Tragen Sie das Fett so auf den Innendurchmesser auf, dass sämtliche Sicken zwischen den Dichtlippen einwandfrei gefüllt werden, siehe Abb. 40/a.



Abb. 41



Abb. 42

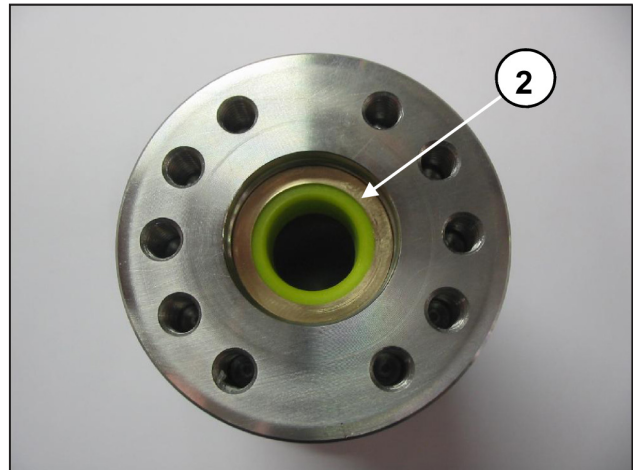

Abb. 43

- Setzen Sie den Stützring ② und die Dichtungshülse ③ wie in Abb. 41, Abb. 42, Abb. 43 gezeigt ein.

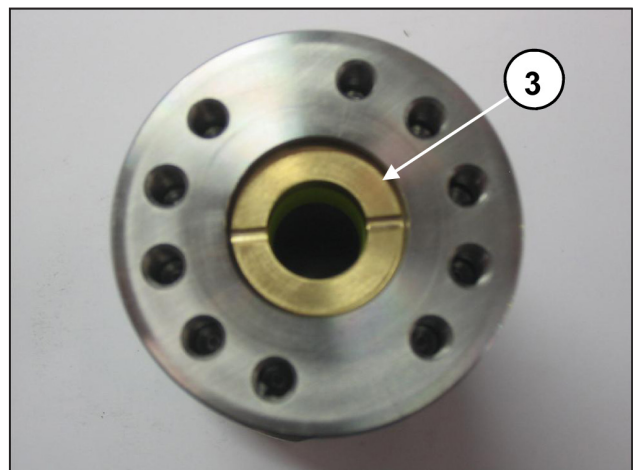

Führen Sie die Dichtungshülse ③ mit nach außen gerichteten Aussparungen (zur Gehäusesseite) gemäß Abb. 42 und Abb. 43 ein.

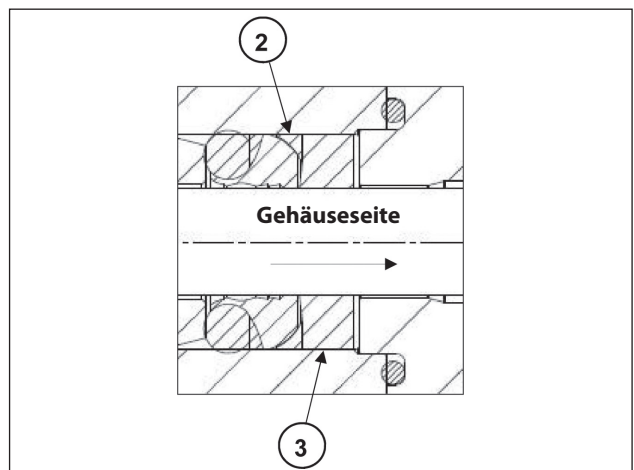

Die ND-Dichtung muss mit Dichtlippe in Arbeitsrichtung des Kolbens in die Buchse eingesetzt werden, siehe Abb. 44 und Abb. 45, wobei der Außendurchmesser leicht mit Silikonfett der Sorte OKS 1110 zu schmieren ist.



Abb. 44



Abb. 45

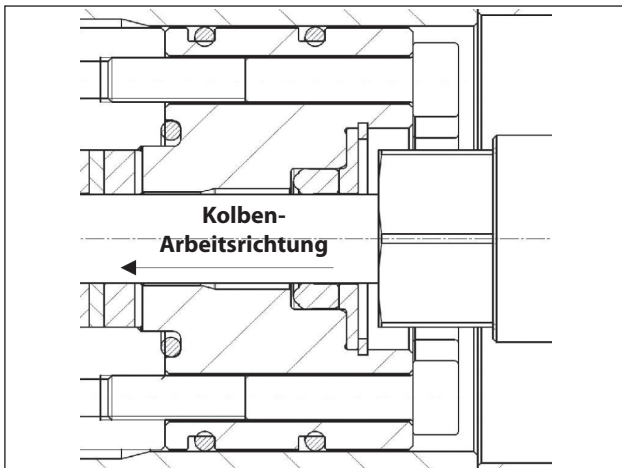

Abb. 46



Abb. 47

- Bauen Sie den Dichtungshalter gemäß Abb. 46 und Abb. 47 ein und tauschen Sie die Bauteile ①②③ aus.

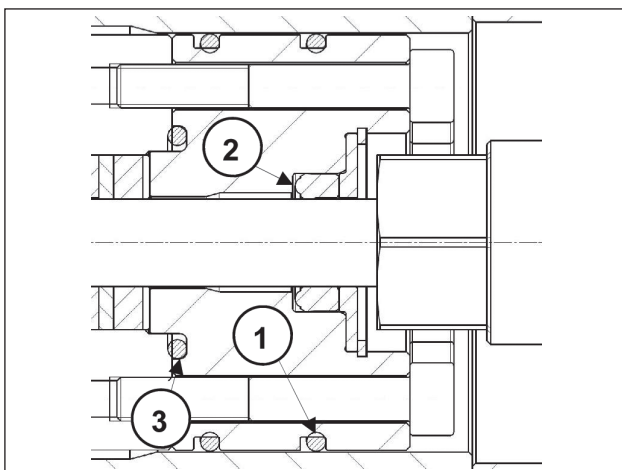

Abb. 48

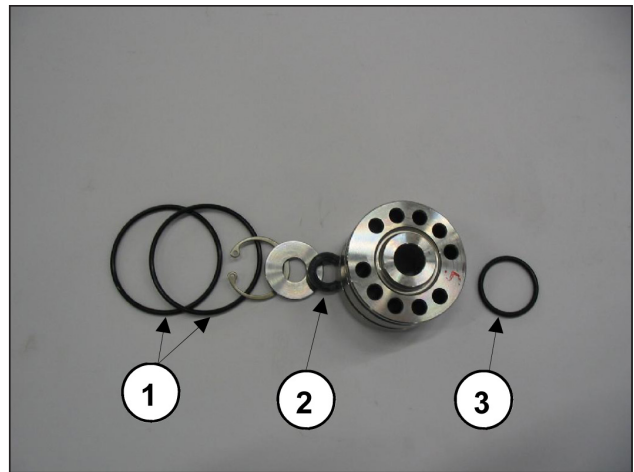
- Montieren Sie die Baugruppe Halter - Buchse durch Andrehen der Schrauben M6x40 von Hand gemäß Abb. 48. Eichen Sie anschließend mit einem Drehmomentschlüssel, wie in Kapitel 3 gezeigt.

3 EICHWERTE FÜR DEN SCHRAUBENANZUG

Ziehen Sie die Schrauben ausschließlich mit einem Drehmomentschlüssel fest.

Beschreibung	Pos. Explosionszeichnung	Anzugsmoment Nm
Befestigungsschraube Deckel	9	10
Ölablassverschluss	11	40
Befestigungsschraube Hebebügel	17	40
Befestigungsschraube Pleueldeckel	16	30*
Kolbenbefestigung	28	20
Anschluss Drosselventil	31	10
Befestigungsschraube Halter	44	15****
Befestigungsschraube Kopf	57	80**
Befestigungsschraube Buchsen	56	35***
Flanschschraube Hydraulikmotor	64	40

* Die Befestigungsschrauben des Pleueldeckels müssen unter Berücksichtigung der Phasen auf Seite 48 angezogen werden.

** Die Befestigungsschrauben des Kopfs müssen in den Phasen und der Reihenfolge gemäß Schema in Abb. 50 festgezogen werden.

*** Die Befestigungsschrauben der Buchsen müssen in den Phasen und der Reihenfolge gemäß Schema in Abb. 50 festgezogen werden.

**** Die Befestigungsschrauben der Halter müssen in einer Phase und der in der Reihenfolge gemäß Schema in Abb. 49 festgezogen werden.



Abb. 49



Die Schrauben - Pos. 44-57 - müssen mit einem Drehmomentschlüssel bei Schmierung des Gewindeschäfts festgezogen werden.

Schraubenanzug Kopf und Buchsen

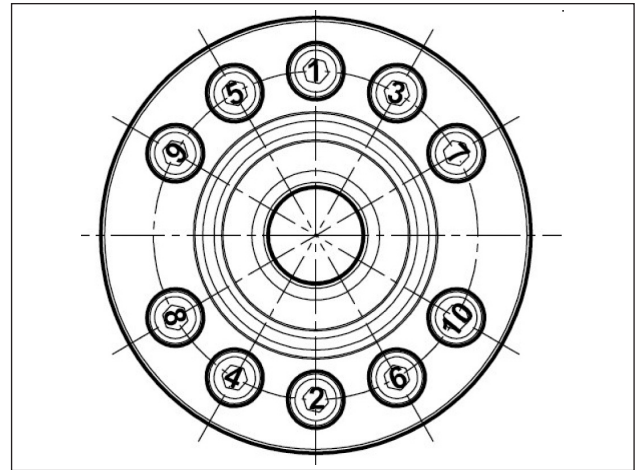

Abb. 50

SCHRITT 1: Anzug der Schrauben M12x260 (Pos. 56) in zwei Phasen und der Reihenfolge lt. Abbildung: (A-B-C-D-E-F-G-H)

Phase 1 = 40 Nm

Phase 2 = 80 Nm

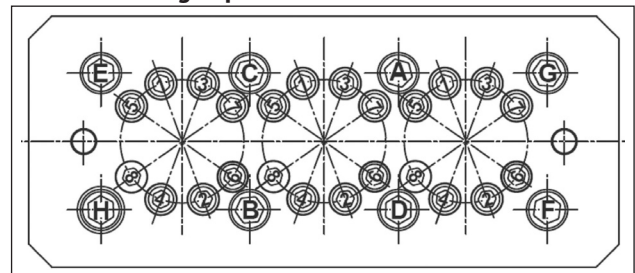
SCHRITT 2: Anzug der Schrauben M8x100 (Pos. 57) in vier Phasen und der Reihenfolge lt. Abbildung: (1-2-3-4-5-6-7-8)

Phase 1 = 20 Nm

Phase 2 = 30 Nm

Phase 3 = 35 Nm

Phase 4 = 35 Nm

4 AUSTAUSCH DER PLEUELAUGENBUCHSE

Sollte im Zuge der Wartungsarbeiten der Austausch der Pleuelaugenbuchse erforderlich sein, gehen Sie folgendermaßen vor:



Nehmen Sie die abgenutzte Buchse äußerst vorsichtig heraus, um die Aufnahme an der Pleuelstange nicht zu beschädigen oder zu zerkratzen.

Setzen Sie die neue Buchse im Kaltzustand und stellen Sie dabei sicher, dass:

- die Schmierbohrung mit der entsprechenden Bohrung an der Pleuelstange fluchtet;
- der Verbindungsschlitz ausgerichtet ist, wie in Abb. 51 gezeigt.



Führen Sie anschließend die mechanischen Bearbeitungen unter strikter Einhaltung der Maße und Toleranzen in Abb. 51 aus.



Abb. 51

5 REPARATURWERKZEUGE

Die Reparatur der Pumpe kann mithilfe geeigneter Werkzeuge mit folgenden Artikelnummern erleichtert werden:

Für den Einbau:

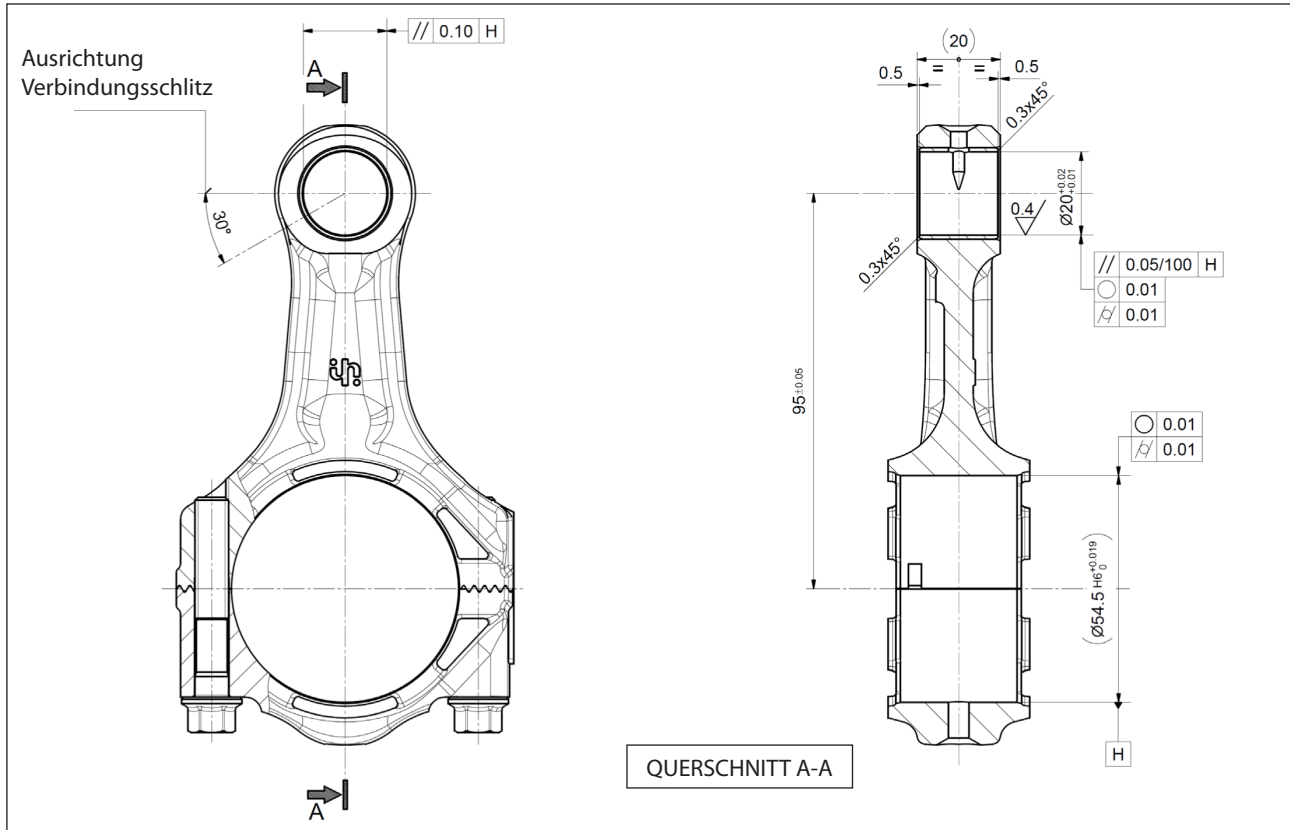
Dichtungshülse VF12; alternativer HD-Dichtring Ø 12x24x13	Art. 27508400
	Art. 27365300
Dichtungshülse VF14; alternativer HD-Dichtring Ø 14x24x13	Art. 27508400
	Art. 27365300
Schraubbolzen Kopfeinbau (2 Teile)	Art. 27508200
Kolbenhülse Ø12	Art. 27508300
Kolbenhülse Ø14	Art. 27508500
Dorn für Ölabbstreifring Pumpenwelle	Art. 27904800
Dorn für Ölabbstreifring Kolbenführung	Art. 27904900

Für den Ausbau:

Ventilsitze VF12 - VF14	Art. 27508000
Schraubbolzen Kopfeinbau (2 Teile)	Art. 27508200
Ölabbstreifring Kolbenführung	Art. 27503900
	Art. 26019400

Índice

1	INTRODUCCIÓN	60
1.1	DESCRIPCIÓN DE LOS SÍMBOLOS	60
2	DECLARACIÓN DE REPARACIÓN	60
2.1	REPARACIÓN DE LA PARTE MECÁNICA	60
2.1.1	<i>Desmontaje de la parte mecánica</i>	60
2.1.2	<i>Montaje de la parte mecánica</i>	62
2.1.3	<i>Clases de minoraciones previstas</i>	64
2.1.4	<i>Desmontaje / Montaje de los cojinetes y calces</i>	64
2.2	REPARACIÓN DE LA PARTE HIDRÁULICA	66
2.2.1	<i>Desmontaje de cabeza - grupos de válvulas</i>	66
2.2.2	<i>Montaje de cabeza – camisas - válvulas</i>	68
2.2.3	<i>Desmontaje del grupo pistón - soportes - juntas</i>	68
2.2.4	<i>Montaje del grupo pistón - soportes - juntas</i>	69
3	CALIBRACIÓN DE AJUSTE DE LOS TORNILLOS	71
4	SUSTITUCIÓN DEL CASQUILLO PIE DE LA BIELA	73
5	HERRAMIENTAS DE REPARACIÓN	73

1 INTRODUCCIÓN

Este manual describe las instrucciones para la reparación de las bombas VF y debe ser atentamente leído y comprendido antes de utilizar la bomba.

De un correcto uso y un mantenimiento adecuado depende el funcionamiento regular y la duración de la bomba.

Interpump Group no se responsabiliza de los daños causados por negligencia o falta de observación de las normas descritas sobre el presente manual.

1.1 DESCRIPCIÓN DE LOS SÍMBOLOS

Leer atentamente lo indicado en el presente manual antes de realizar cada operación.



Señal de advertencia



Leer atentamente lo indicado en el presente manual antes de realizar cada operación.



Señal de Peligro

Utilizar gafas de protección



Señal de Peligro

Utilizar guantes de protección para realizar cualquier tipo de operación

2 DECLARACIÓN DE REPARACIÓN



2.1 REPARACIÓN DE LA PARTE MECÁNICA

Las operaciones de reparación de la parte mecánica deben ser realizadas después de haber retirado todo el aceite del cárter. Para eliminar el aceite es necesario retirar: la varilla de nivel de aceite pos. ①, y a continuación el tapón pos. ②, Fig. 1.

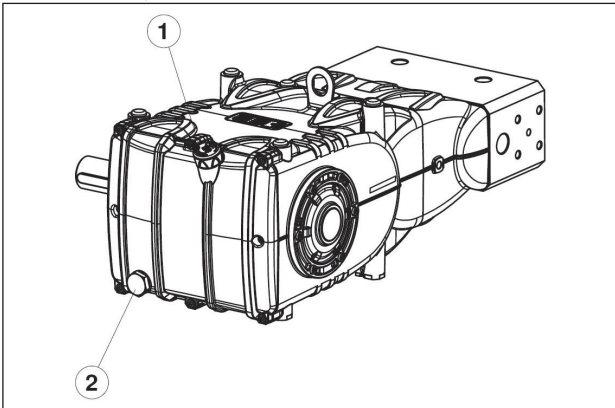

Fig. 1



El aceite agotado debe ser colocado en un recipiente adecuado y eliminado en los correspondientes centros. No debe dispersarse en el ambiente.

2.1.1 Desmontaje de la parte mecánica

Las operaciones descritas van realizadas después de haber retirado la parte hidráulica, los pistones de cerámica y los protectores de salpicaduras de la bomba (apar. 2.2.3, 2.2.4).

Para realizar una correcta secuencia desmontar siguiendo este orden:

- la lengüeta del eje bomba
- la tapa posterior
- el sombrerete de las bielas del modo siguiente: desatornillar los tornillos de fijación del sombrerete, extraer los sombreretes de la biela con los correspondientes semi cojinetes inferiores (Fig. 2) prestando atención en desmontar siguiendo la correspondiente secuencia numerada.

Para evitar posibles errores, sombreretes y cilindros de la biela han sido enumerados en un lateral (Fig. 2/a, pos. ①).

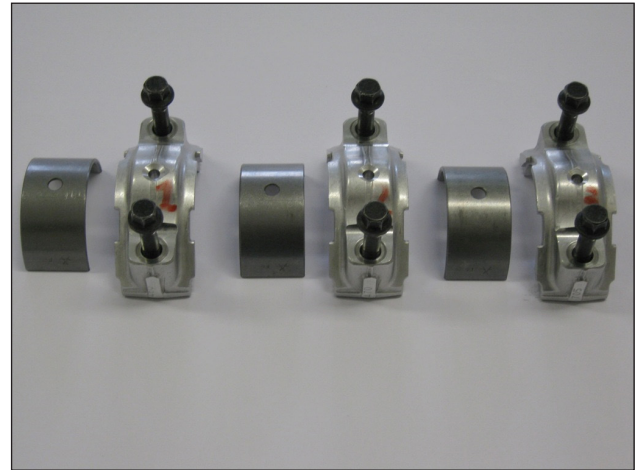

Fig. 2

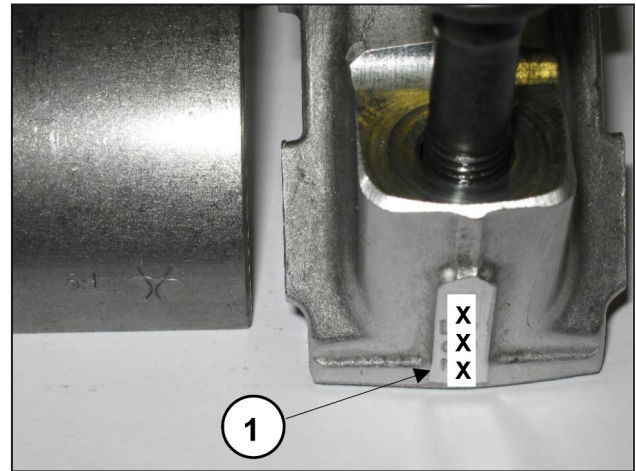

Fig. 2/a

- las tapas laterales utilizando para realizar la extracción 3 tornillos M6x50 completamente roscados introduciéndolos en los orificios roscados como se indica en la Fig. 3.

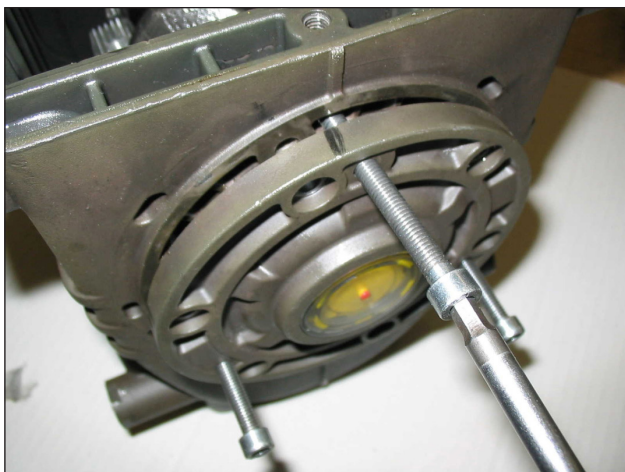

Fig. 3

- Empujar hacia delante las guías del pistón con las correspondientes bielas para facilitar la extracción lateral del eje bomba. Sobre el eje se visualizan dos referencias (indicadas con 1 en la Fig. 4 y la Fig. 4/a), y éstas deben dirigirse hacia el operador para facilitar la extracción.

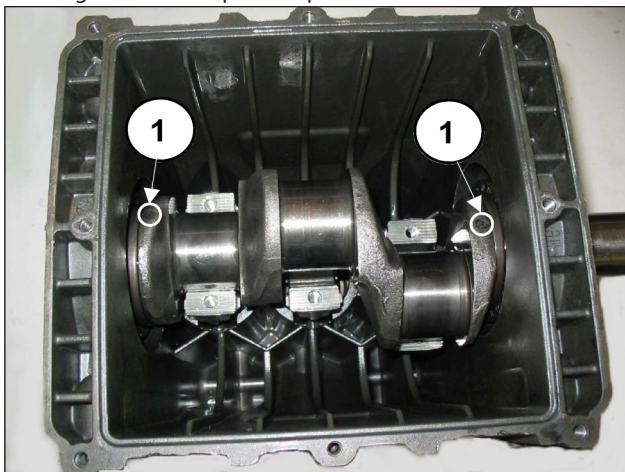

Fig. 4

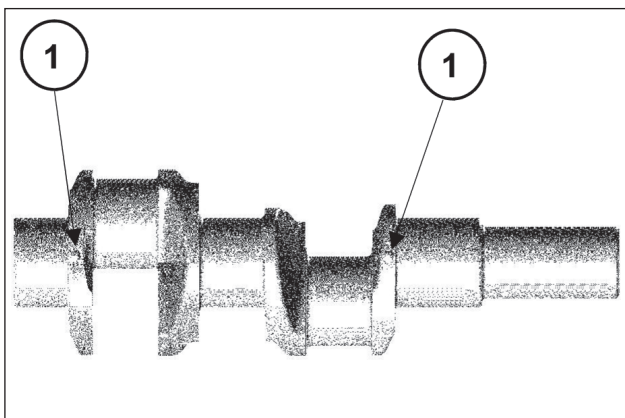

Fig. 4/a

- Extraer el eje de la bomba.
- Completar el desmontaje de los grupos de bielas extrayéndolos desde el cárter bomba y retirando las clavijas de las guías pistón.
- Desmontar las anillas de retención del eje bomba utilizando herramientas comunes.
- Desmontar las anillas de retención de las guías pistón siguiendo el siguiente procedimiento:

Utilizar el extractor cód. 26019400 (Fig. 5, pos. ①) y la pinza cód. 27503900 (Fig. 5, pos. ②). Introducir la pinza hasta que encaje sobre la anilla de retención con la ayuda de un martillo (Fig. 5/a), a continuación atornillar el extractor a la pinza y actuar sobre el martillo de timbre del extractor (Fig. 5/b) hasta extraer la anilla que se desea sustituir (Fig. 5/c).

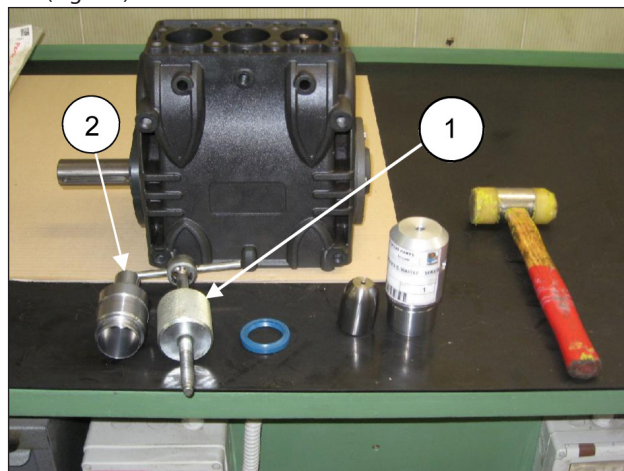

Fig. 5



Fig. 5/a



Fig. 5/b



Fig. 5/c

2.1.2 Montaje de la parte mecánica

Después de haber verificado la limpieza del cárter, proceder al montaje de la parte mecánica respetando el siguiente procedimiento:



- Montar los semicojinetes superiores e inferiores en sus correspondientes sedes de las bielas y de los sombreretes.

Asegurarse que las muescas de referencia de los semicojinetes superior (Fig. 6, pos. ①) e inferior (Fig. 6/a, pos. ②) sean posicionadas en las correspondientes sedes de la biela y del sombrerete.

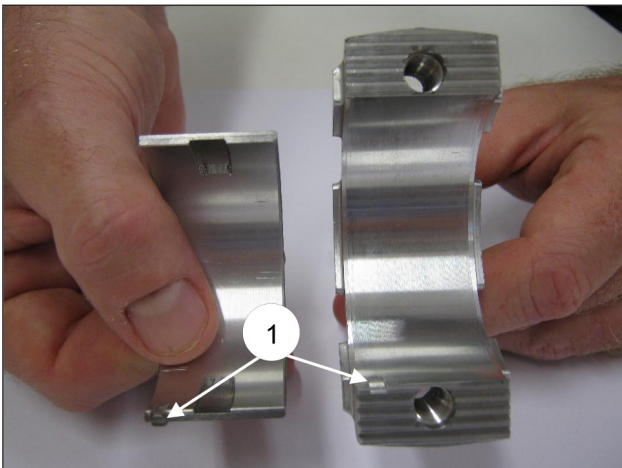

Fig. 6

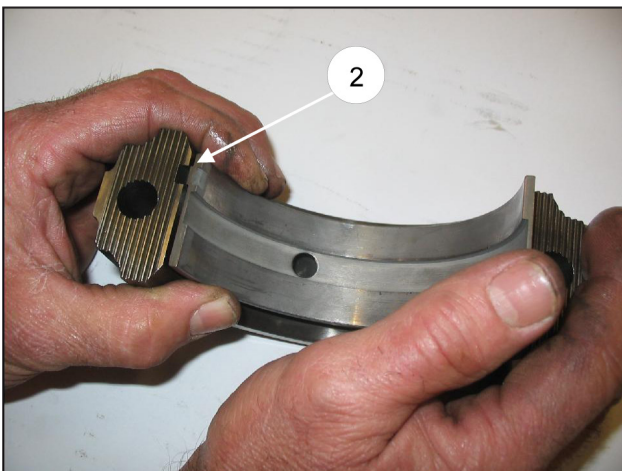

Fig. 6/a

- Introducir en el cárter bomba los grupos de guía del pistón / biela orientando la numeración presente sobre el cilindro de la biela hacia la parte superior del cárter. Para facilitar la introducción del eje bomba (sin lengüeta) es indispensable repetir la operación efectuada al desmontaje empujando en fondo los grupos de guía pistón / biela (apar. 2.1.1).
- Antes de proceder al montaje de la tapa lateral lado P.T.O. verificar las condiciones del labio de retención de la anilla radial y de la correspondiente zona de contacto sobre el eje.

Si es necesario sustituirla, colocar la nueva anilla utilizando la herramienta (cód. 27904800) como se indica en la fig. Fig. 7.



En el caso que el eje bomba presente un desgaste diametral en la zona de contacto con el labio de retención, con el fin de evitar tener que realizar la operación de rectificación, es posible volver a colocar la anilla hasta que encaje con la tapa como se indica en la Fig. 7.

Antes de montar las tapas laterales asegurarse de la presencia de las juntas tóricas de retención sobre ambas y de las anillas de calce sobre solamente la tapa del lado del testigo.

Para facilitar la introducción del primer tramo y de la correspondiente introducción de las tapas sobre el cárter, se recomienda utilizar N° 3 tornillos M6 x 40 parcialmente roscados, (Fig. 8, pos. ①) para después completar la operación con los tornillos incluidos en la dotación (M6x18).

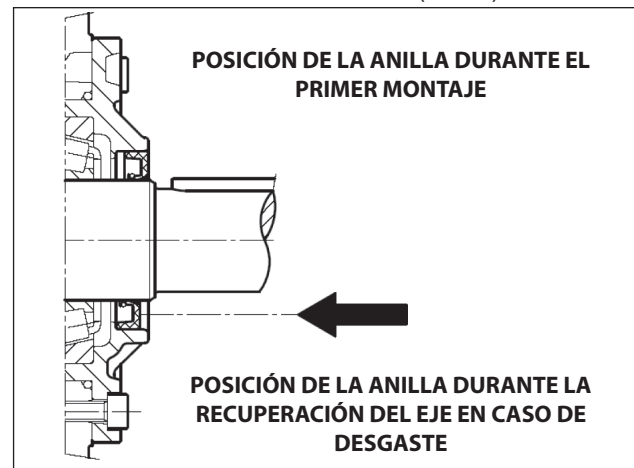

Fig. 7

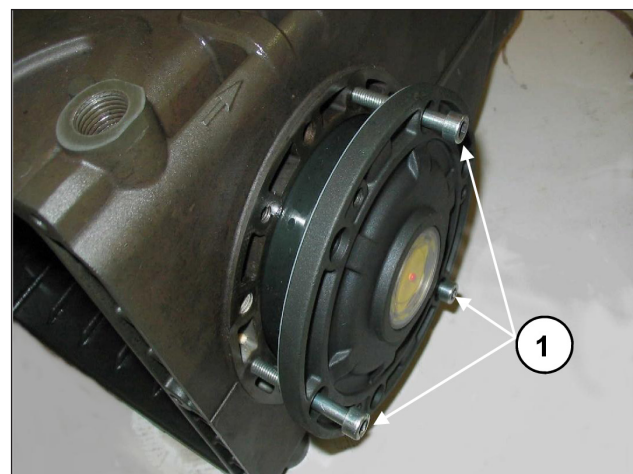

Fig. 8



- Acoplar los sombreretes de la biela a los correspondientes cilindros siguiendo la numeración (Fig. 9, pos ①).

Prestar atención al sentido correcto de montaje de los sombreretes.

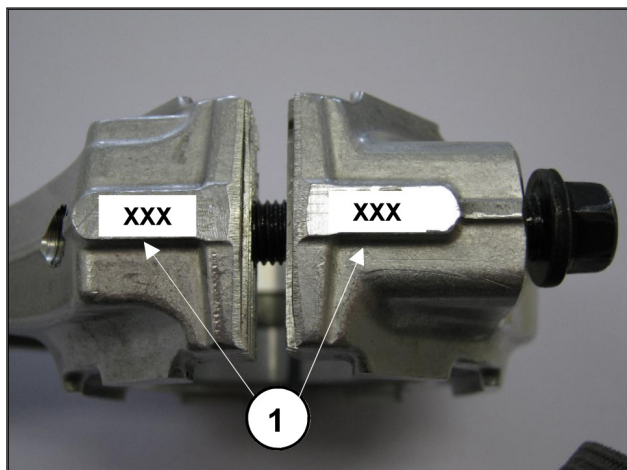

Fig. 9

- Fijar los sombreretes a los correspondientes cilindros de la biela utilizando tornillos M8x1x48 (Fig. 10) lubricando sea la parte inferior de la cabeza que el tallo roscado, realizando dos fases diferentes:



1. **Atornillar manualmente los tornillos hasta el inicio de ajuste**
 2. **Par de apriete** **30 Nm**
- Como alternativa realizar:**
1. **Par de pre-apriete** **10-15 Nm**
 2. **Par de apriete** **30 Nm**



Fig. 10

- Después de haber completado la operación de ajuste, verificar que el cabezal de la biela realice un juego lateral en los dos sentidos.
- Montar las nuevas anillas de retención de las guías pistón hasta que encaje con la correspondiente sede sobre el cárter de la bomba (Fig. 11) siguiendo el procedimiento aquí descrito:

Utilizar la herramienta cód. 27904900 compuesto por casquillo cónico y tampón. Atornillar el casquillo cónico en el orificio que se encuentra presente sobre la guía pistón (Fig. 11/a), introducir la nueva anilla de retención sobre el tampón y encajarlo (determinado por la altura del mismo tampón) en la sede sobre el cárter bomba (Fig. 11/b), retirar el casquillo cónico (Fig. 11/c).

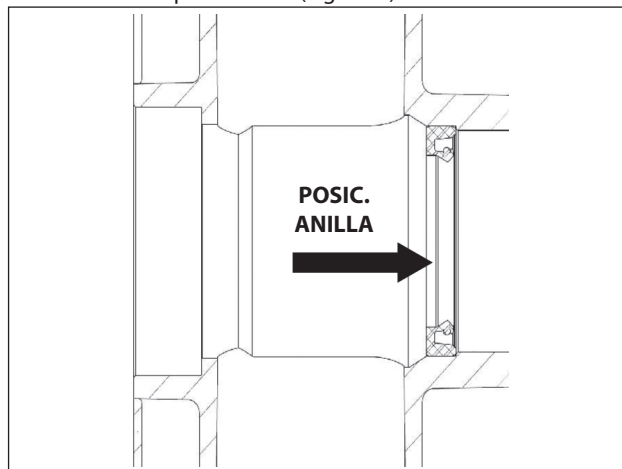

Fig. 11



Fig. 11/a



Fig. 11/b



Fig. 11/c

- Montar la tapa posterior completa de la junta tórica de retención, posicionando el orificio de la varilla de nivel de aceite hacia arriba.
- Introducir el aceite en el cárter tal y como se indica en el **Manual de uso y mantenimiento**.

2.1.3 Clases de minoraciones previstas

TABLA DE MINORACIONES POR EJE ACODADO Y SEMICOJINETES DE LA BIELA			
Clases de recuperación (mm)	Código semicojinete superior	Código semicojinete inferior	Rectificación sobre el diámetro del perno del eje (mm)
0.25	90924100	90924400	Ø49.75 0/-0.02 Ra 0.4 Rt 3.5
0.50	90924200	90824500	Ø49.50 0/-0.02 Ra 0.4 Rt 3.5

2.1.4 Desmontaje / Montaje de los cojinetes y calces

La tipología de los cojinetes (con rodillos cónicos), garantiza la ausencia del juego axial del eje acodado; los calces van definidos para alcanzar tal finalidad. Para el desmontaje / montaje y la posible sustitución deben seguirse atentamente las siguientes indicaciones:

A) Desmontaje / Montaje del eje acodado sin sustitución de los cojinetes

Después de haber desmontado las tapas laterales, tal y como se indica en el punto 2.1.1, controlar el estado de los rodillos y de las correspondientes pistas; si todas las partes son idóneas, limpiar cuidadosamente los componentes utilizando un desengrasante adecuado y distribuir de manera uniforme aceite lubricante.

Pueden reutilizarse los espesores anteriores prestando atención en introducirlos solamente debajo de la tapa del lado del testigo.

Una vez montado el grupo completo (brida lado testigo + eje + brida lado motor) y apretados los tornillos de las tapas con el par previsto, verificar que el par de rodamiento del eje, con bielas no conectadas, sea 4 Nm como mínimo y 7 Nm como máximo.

Para acercar las dos tapas laterales al cárter se pueden utilizar N°3 tornillos M6x40 para una primera fase de orientación como se indica anteriormente, y los tornillos previstos para la fijación final.

El par de rodamiento del eje con bielas conectadas no deberá superar el valor de 8 Nm.

B) Desmontaje / Montaje del eje acodado con sustitución de los cojinetes

Después de haber desmontado las tapas laterales, como se ha indicado anteriormente, retirar el casquillo externo de los cojinetes de los correspondientes alojamientos sobre las tapas utilizando un extractor adecuado como se indica en las Fig. 12 y Fig. 12/a.

Retirar el casquillo interno de los cojinetes de los dos extremos del eje utilizando siempre un extractor adecuado o, como alternativa, un simple "arrancapasador" como se indica en la Fig. 13.



Fig. 12

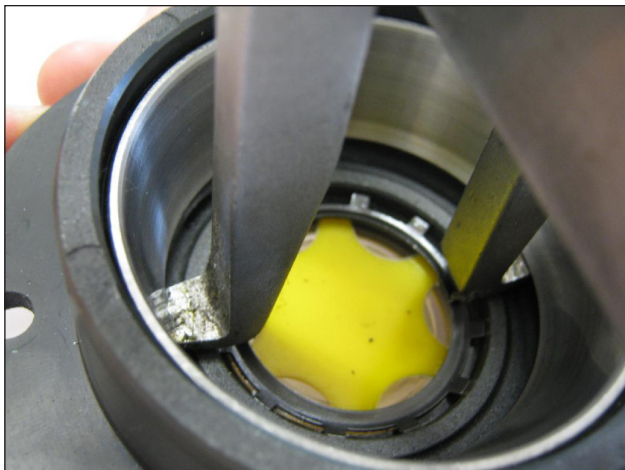

Fig. 12/a



Fig. 13

Los nuevos cojinetes pueden ser montados en frío con un toma o balancín, apoyándolos necesariamente sobre la superficie lateral de los casquillos que van a conectarse con las correspondientes anillas. La operación de conexión podría ser facilitada calentando las partes interesadas a una temperatura comprendida entre los 120 - 150°C (250 - 300°F), asegurándose que los casquillos se encajen en los correspondientes sedes.



No intercambiar nunca las partes de los dos cojinetes

Determinación del paquete de los ceses:

Realizar la operación con los grupos guía pistón-bielas montados, los sombreretes de la biela desconectados y las bielas empujadas hacia abajo. Introducir el eje bomba sin lengüeta en el cárter, asegurándose que el codo P.T.O salga del lado previsto.

Fijar la brida del lado P.T.O al cárter, prestando la máxima atención al labio de la anilla de retención, según el procedimiento descrito anteriormente y apretar los tornillos de fijación al par previsto.

A continuación embocar la brida del lado testigo sin espesores en el cárter e iniciar a acercarla atornillando manualmente los tornillos M6x40 de igual manera, con pequeñas rotaciones de poder generar un avance lento y correcto de la tapa.

A la vez verificar, girándolo manualmente, que el eje gire libremente.

Continuando el procedimiento con esta modalidad se llegará a advertir un repentino aumento de dureza en la rotación del eje.

A este punto interrumpir el avance de la tapa y aflojar por completo los tornillos de fijación.

Con la ayuda de un espesímetro detectar el juego entre la tapa lateral y el cárter de la bomba (ver Fig. 14).



Fig. 14

Determinar el paquete de los espesores utilizando la tabla inferior:

Medida Detectada	Tipo de Espesor	Nº piezas
De: 0,05 a: 0,10	/	/
De: 0,11 a: 0,20	0,1	1
De: 0,21 a: 0,30	0,1	2
De: 0,31 a: 0,35	0,25	1
De: 0,36 a: 0,45	0,35	1
De: 0,46 a: 0,55	0,35 0,10	1 1
De: 0,56 a: 0,60	0,25	2
De: 0,61 a: 0,70	0,35 0,25	1 1



Fig. 15

Determinado por la tabla tipo y número de espesores efectuar el siguiente control: montar el paquete de espesores sobre el centrado de la tapa del lado testigo (Fig. 15), fijar la tapa al cárter siguiendo el procedimiento del apart. 2.1.2, apretar los tornillos correspondientes con el par previsto.

Verificar que el par resistente de rotación del eje entre en un valor comprendido entre 4 Nm y 6 Nm.

Si tal par resulta correcto realizar la conexión de las bielas al eje acodado y a las fases sucesivas, de manera diversa definir el paquete de espesores repitiendo las operaciones.

2.2 REPARACIÓN DE LA PARTE HIDRÁULICA

2.2.1 Desmontaje de cabeza - grupos de válvulas

La cabeza no requiere un mantenimiento periódico.

Las intervenciones se limitan a la inspección o sustitución de las válvulas, en el caso que sea necesario:

Para extraer los grupos de válvula operar del siguiente modo:

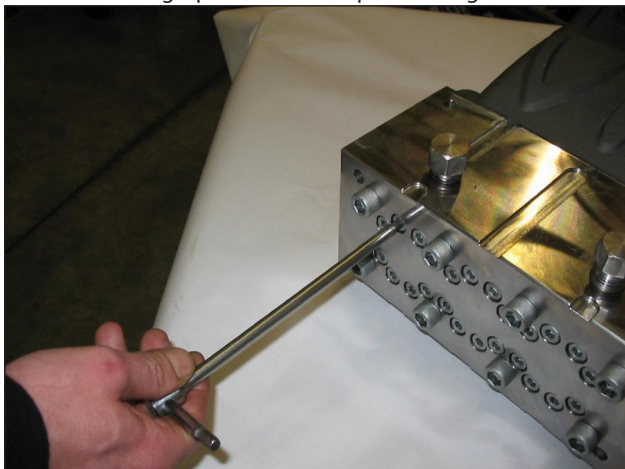

Fig. 16



- Aflojar, sin extraerlos, los tornillos M8x100 que fijan las camisas al cabezal para liberarlas, como se indica en la Fig. 16.

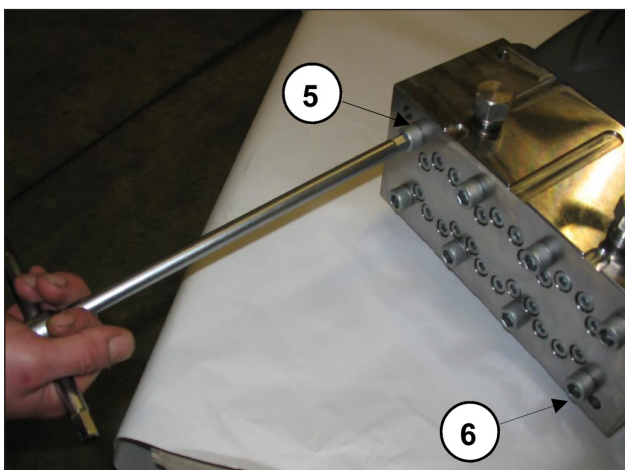

Fig. 17

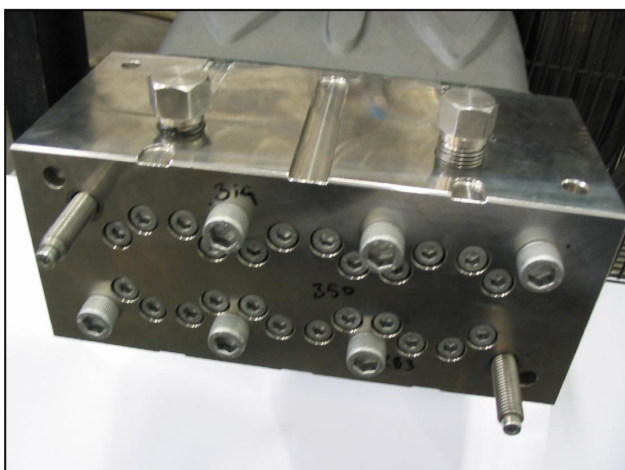

Fig. 18

- Aflojar los tornillos del cabezal M12x260 5 y 6 como se indica en la Fig. 17 y sustituirlos con dos tornillos - clavija de servicio (cód. 27508200) como se indica en la fig. Fig. 18. A continuación, extraer los tornillos restantes.



Fig. 19

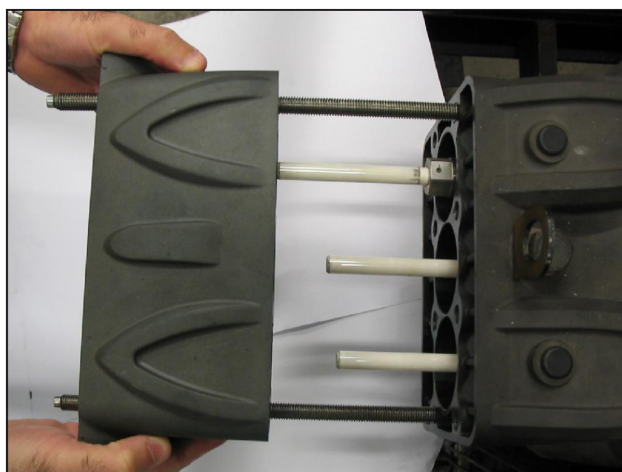

Fig. 20

- Desmontar la cabeza y el distanciador de las camisas del cárter de la bomba como se indica en la Fig. 19 y la Fig. 20.



Fig. 21

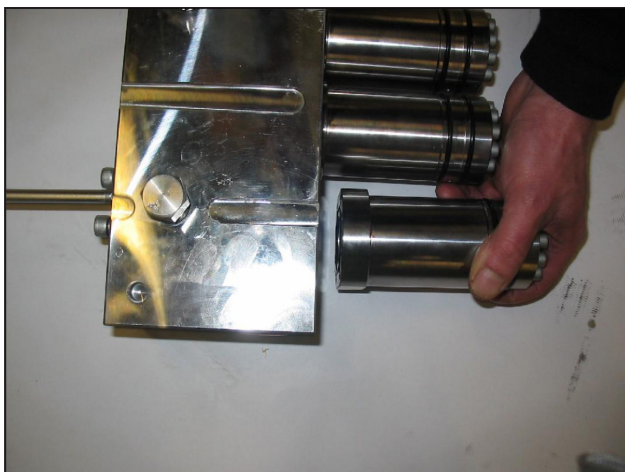

Fig. 22

- Extraer los tornillos M8x100 que fijan las camisas a la cabeza como se indica en la Fig. 21 y seguir los pasos indicados en la Fig. 22.

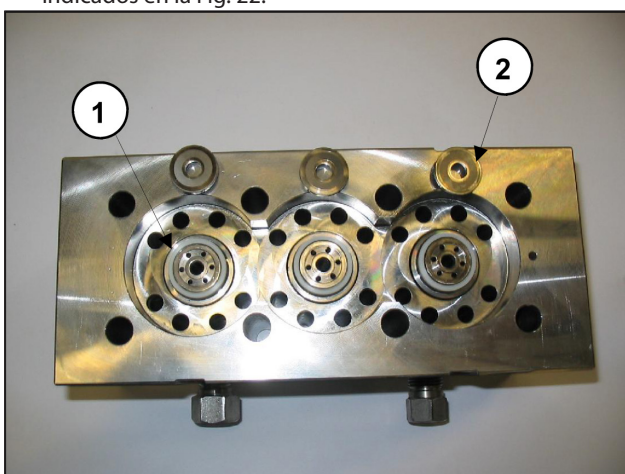

Fig. 23



Durante el desmontaje de las camisas es importante no perder las sedes de las válvulas ① ni las válvulas planas ②, como se indica en la Fig. 23, ya que al estar montadas sólo por contacto podrían caerse.

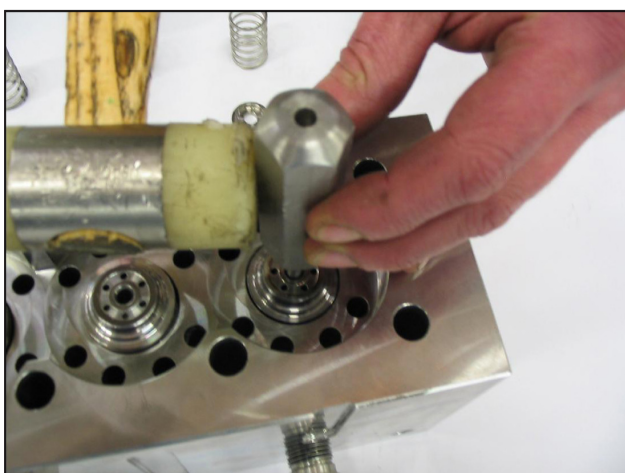

Fig. 24



Si las sedes de la válvula están bloqueadas en la cabeza debido a los depósitos de cal o al óxido, desbloquearlas introduciendo la herramienta adecuada (cód. 27508000 "VF12" - "VF14") en el orificio de aspiración como se indica en la Fig. 24.

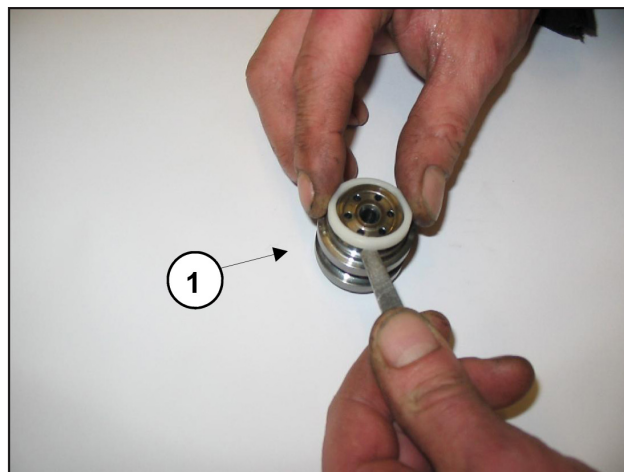

Fig. 25

- Extraer las sedes de la válvula ① como se indica en la Fig. 25, controlar el desgaste de los componentes y sustituirlos si es necesario.



Cada vez que se inspeccionan las válvulas, se deben sustituir todas las anillas de retención y las juntas tóricas de retención frontal situadas entre la camisa y la cabeza, y entre la cabeza y el distanciador de las camisas de la zona del orificio de recirculación. Antes de volver a montar los componentes, limpiar y secar tanto los componentes como los alojamientos internos de la cabeza.

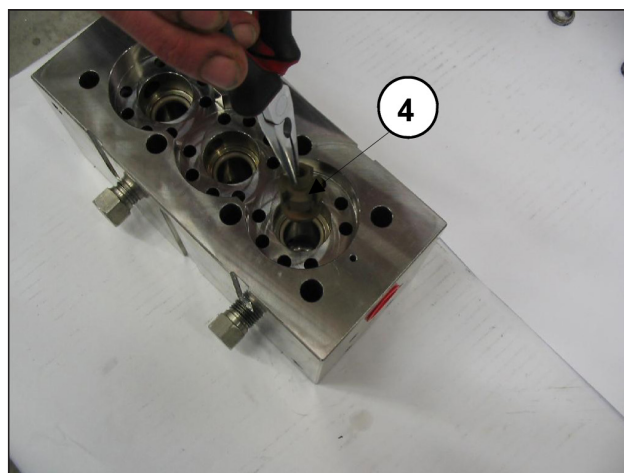

Fig. 26

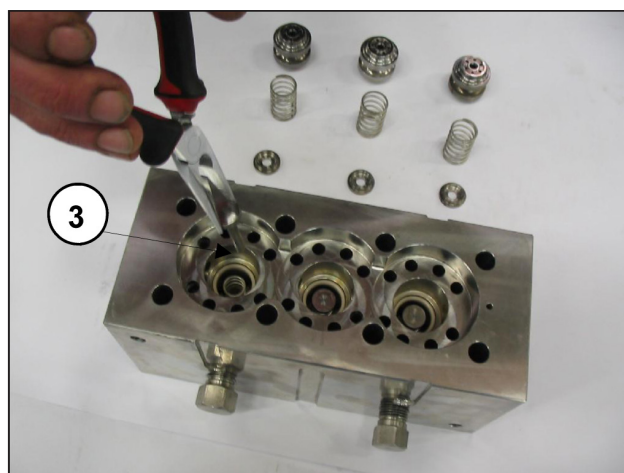

Fig. 27

- Extraer los platillos de envío ③, las guías ④ y los muelles como se indica en la Fig. 26 y la Fig. 27, controlar el desgaste y sustituirlos si es necesario. En cualquier caso, respetar los intervalos indicados en la tabla "MANTENIMIENTO PREVENTIVO" del capítulo 11 del **Manual de uso y mantenimiento**.

2.2.2 Montaje de cabeza – camisas - válvulas



Para volver a montar los componentes repetir las operaciones arriba descritas en orden contrario, poniendo atención a montar correctamente el distanciador de las camisas: cuando la pieza está ya montada, las dos descargas de fusión situadas a los dos lados deben estar orientadas hacia la parte inferior del cárter (lado de fijación de la bomba).

Cabezas - camisas: montar y ajustar los tornillos de fijación de la cabeza y ajustar los tornillos de fijación de las camisas.

Respetar los valores de los pares de apriete y las secuencias indicadas en el capítulo 3.

2.2.3 Desmontaje del grupo pistón - soportes - juntas

El grupo pistón no requiere un mantenimiento periódico. Sólo es necesario inspeccionar el drenaje del circuito de refrigeración. Si se detectan anomalías y oscilaciones en el manómetro de envío o pulsaciones en el tubo de drenaje del circuito de refrigeración (si es elástico), controlar y sustituir el paquete de juntas.

Para extraer los grupos de pistón operar del siguiente modo:

- Desmontar la cabeza y el distanciador de las camisas del cárter de la bomba como se indica en el apart. 2.2.1 (Fig. 19 y Fig. 20).

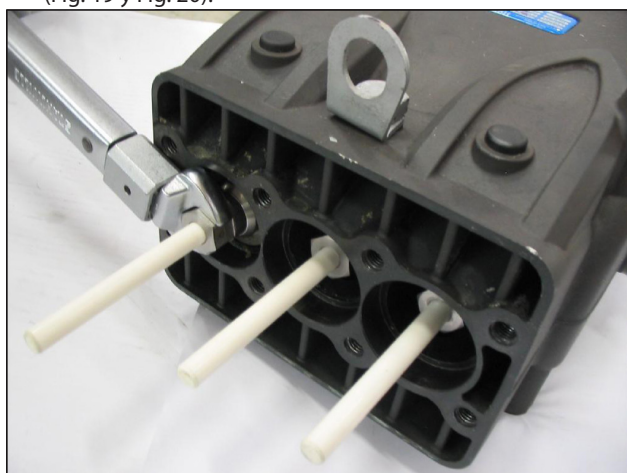

Fig. 28

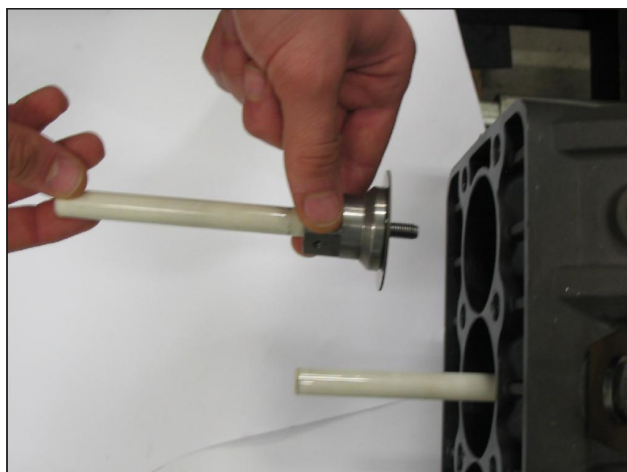

Fig. 29

- Desmontar las bombas con una llave de horquilla y controlar el desgaste como se indica en la Fig. 28 y la Fig. 29; sustituir las si es necesario.

- Extraer los tornillos M6x40 que fijan el soporte de la camisa como se indica en la Fig. 30 y desmontar el soporte como se indica en la Fig. 31.



Fig. 30



Fig. 31

- Desmontar la anilla seeger y la anilla de retención de las juntas como se indica en la Fig. 32 y extraer la junta de retención LP (baja presión) ① con un pasador de plástico, como se indica en la Fig. 33.



Fig. 32

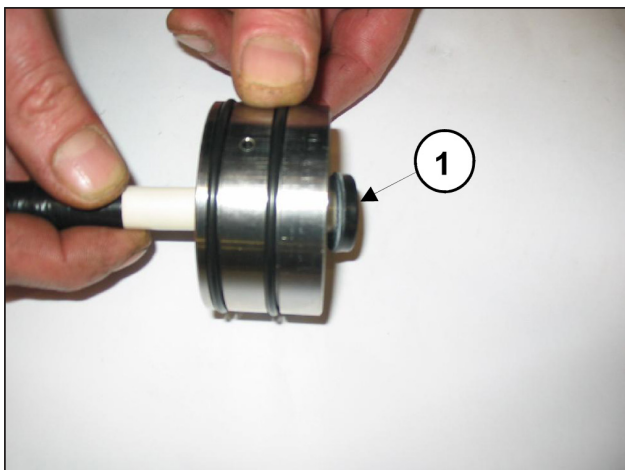

Fig. 33



Sustituir las juntas de baja presión y las juntas tóricas cada vez que se realicen operaciones de desmontaje.

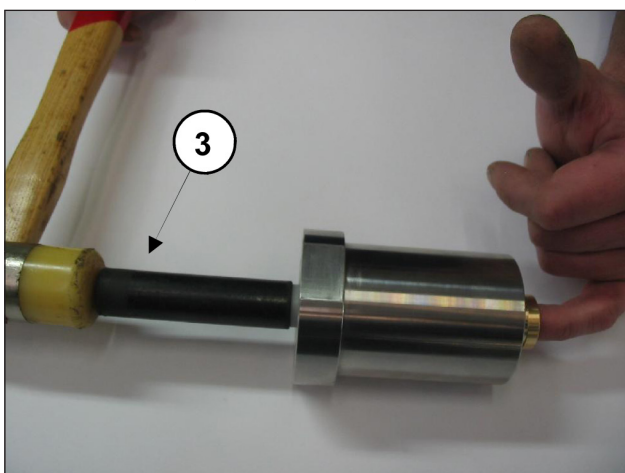

Fig. 34

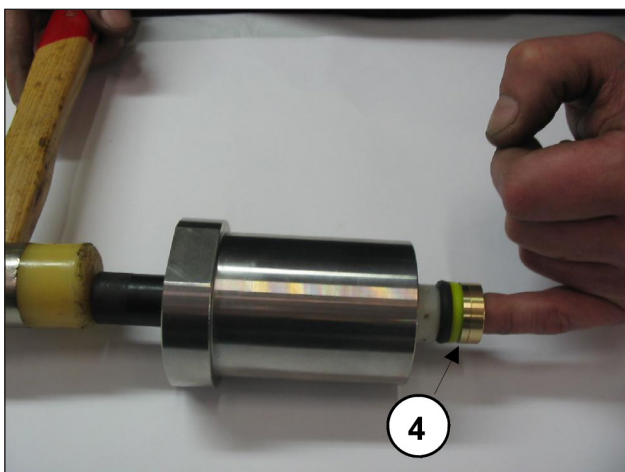

Fig. 35

- Con la camisa desmontada del soporte de juntas y utilizando una clavija de plástico ③ como se indica en la Fig. 34, extraer el paquete HP (alta presión) ④ como se indica en la Fig. 35.



Sustituir el paquete HP (Fig. 31, pos. ④) cada vez que se realicen operaciones de desmontaje.

2.2.4 Montaje del grupo pistón - soportes - juntas

Para montar los componentes realizar las operaciones arriba descritas en orden contrario respetando las secuencias indicadas a continuación; para los valores de los pares y las secuencias, respetar las indicaciones contenidas en el capítulo 3.

- Introducir el casquillo superior en la camisa.



Fig. 36



Fig. 37



Para garantizar una correcta posición axial del casquillo utilizar la herramienta (cód. 27508300 válida para bombas de tipo VF12 y cód. 27508500 válida para bombas de tipo VF14) como se indica en la Fig. 36 y la Fig. 37.



Fig. 38

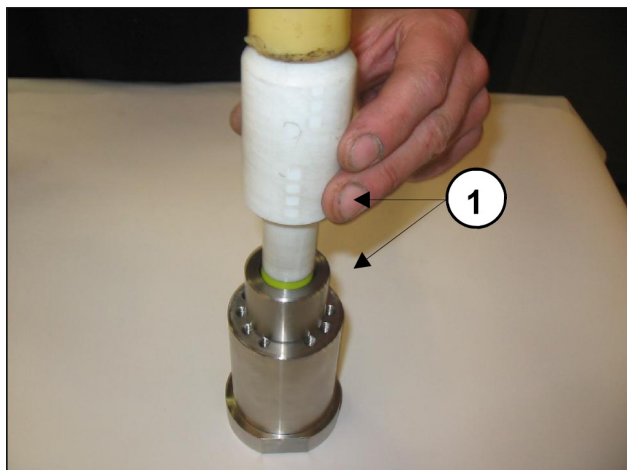

Fig. 39

- Introducir el paquete H.P. (alta presión); para evitar daños debido a la ligera interferencia entre la junta y la camisa, se recomienda utilizar la herramienta indicada en la Fig. 38 y la Fig. 39 pos. ① (cód. 27508400 y cód. 27365300).

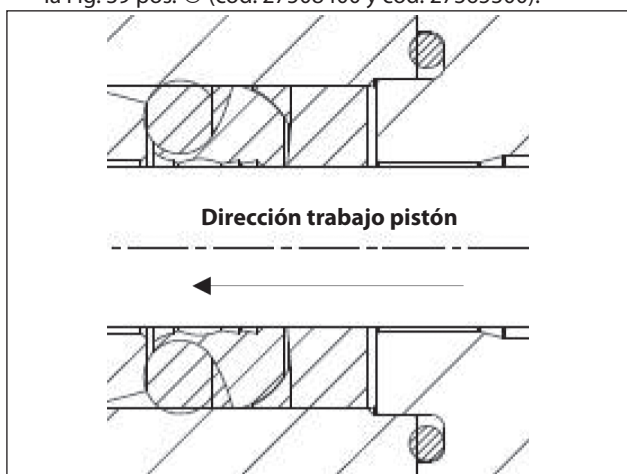

Fig. 40

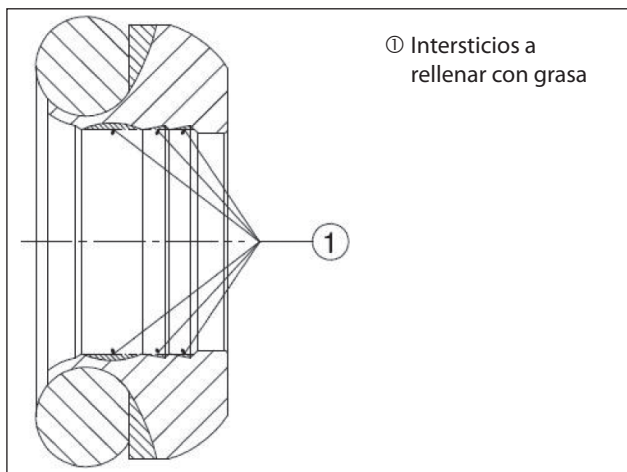

Fig. 40/a



La junta H.P. se ha de introducir en la camisa con la junta tórica energizante de retención orientada hacia la dirección de trabajo del pistón, como se indica en la Fig. 38 y la Fig. 40.



Antes de montarlas en la sede, las juntas de H.P. se deben lubricar con grasa de silicona de tipo OK S1110 como se indica a continuación:

- Lubricar el diámetro externo ligeramente.
- Aplicar la grasa en el diámetro interno rellenando con cuidado todos los intersticios comprendidos entre los labios de retención, como se indica en la Fig. 40/a.

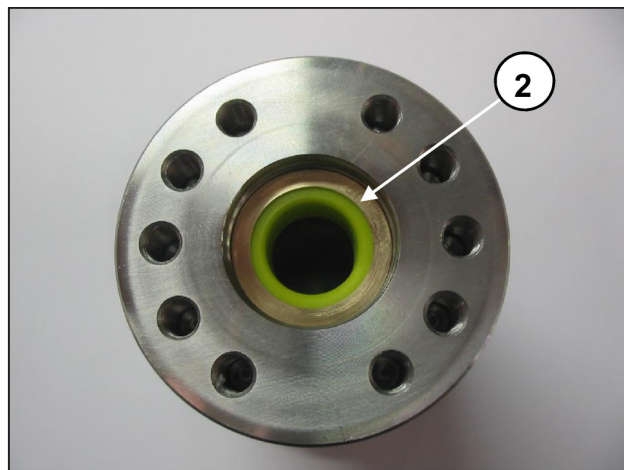

Fig. 41

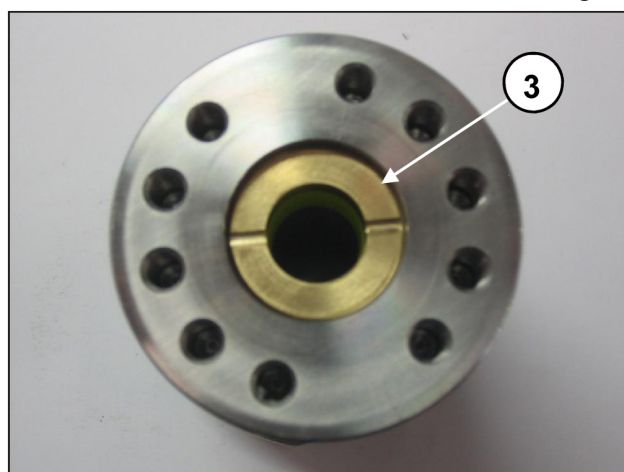

Fig. 42

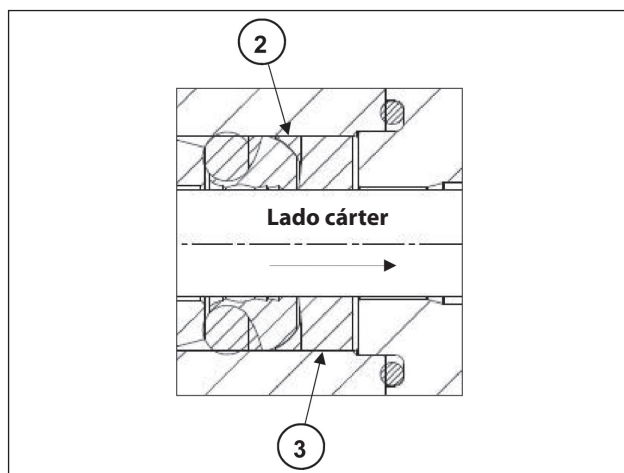

Fig. 43

- Introducir la anilla anti-extrusora ② y el casquillo de las juntas ③ como se indica en la Fig. 41, la Fig. 42 y la Fig. 43.



El casquillo de las juntas ③ se ha de introducir en la camisa con las descargas orientadas hacia el exterior (lado cárter) como se indica en la Fig. 42 y la Fig. 43.



La junta L.P. se ha de introducir en la camisa con el labio de retención orientado hacia la dirección de trabajo del pistón, como se indica en la Fig. 44 y la Fig. 45, lubricando ligeramente el diámetro externo con grasa de silicona de tipo OKS 1110.

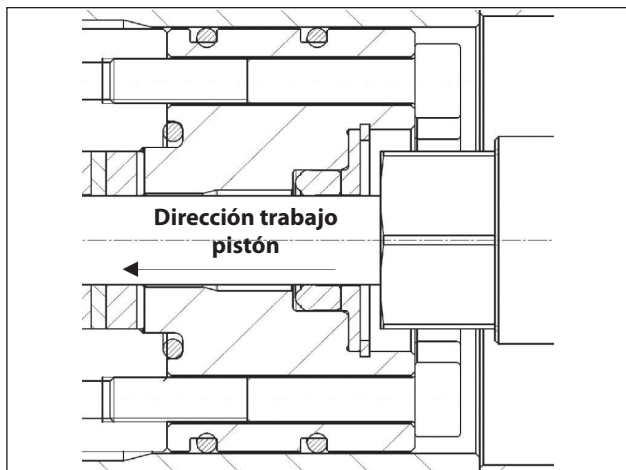

Fig. 44



Fig. 48

- Ensamblar el grupo soporte - camisa y apretar a mano los tornillos M6x40 como se indica en la Fig. 48. A continuación, apretar con la llave dinamométrica como se indica en el capítulo 3.



Fig. 45

3 CALIBRACIÓN DE AJUSTE DE LOS TORNILLOS

El ajuste de los tornillos debe realizarse exclusivamente con una llave dinamométrica.

Descripción	Posic. dib. desglosado	Par de apriete Nm
Tornillos de fijación de las tapas	9	10
Tapón de descarga del aceite	11	40
Tornillos de fijación del soporte de elevación	17	40
Tornillo de fijación del sombrerete de la biela	16	30*
Fijación de los pistones	28	20
Racor estrangulador	31	10
Tornillo de fijación de los soportes	44	15****
Tornillos de fijación de la cabeza	57	80**
Tornillo de fijación de las camisas	56	35***
Tornillo de la brida del motor hidráulico	64	40

* Los tornillos de fijación del sombrerete de la biela se deben apretar respetando las secuencias indicadas en pag. 63.

** Los tornillos de fijación del cabezal deben ser ajustados respetando las secuencias y el orden indicado en el esquema de la Fig. 50.

*** Los tornillos de fijación de las camisas deben ser ajustados respetando las secuencias y el orden indicado en el esquema de la Fig. 50.

**** Los tornillos de fijación de los soportes deben ser ajustados en una única fase respetando el orden indicado en el esquema de la Fig. 49.

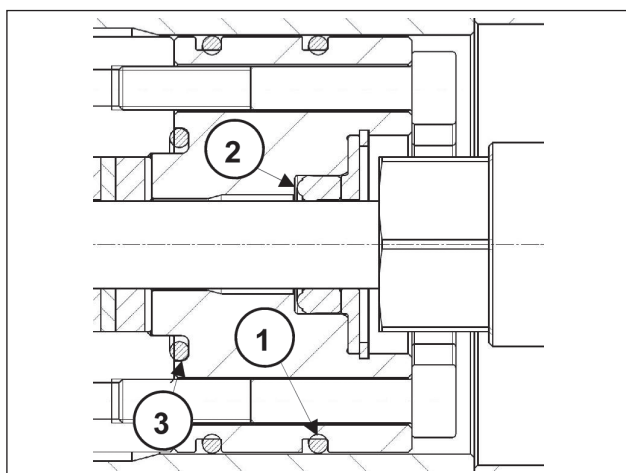

Fig. 46

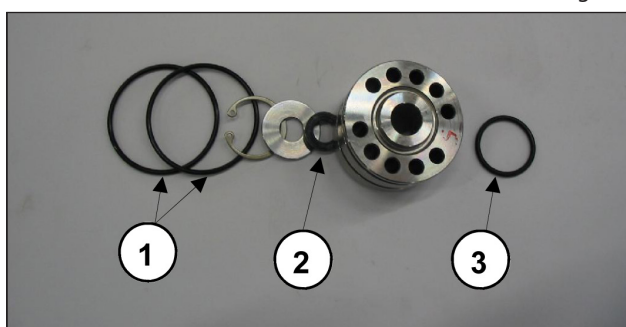

Fig. 47

- Montar el grupo de soporte de las juntas como se indica en la Fig. 46 y la Fig. 47, sustituyendo los componentes ①②③.

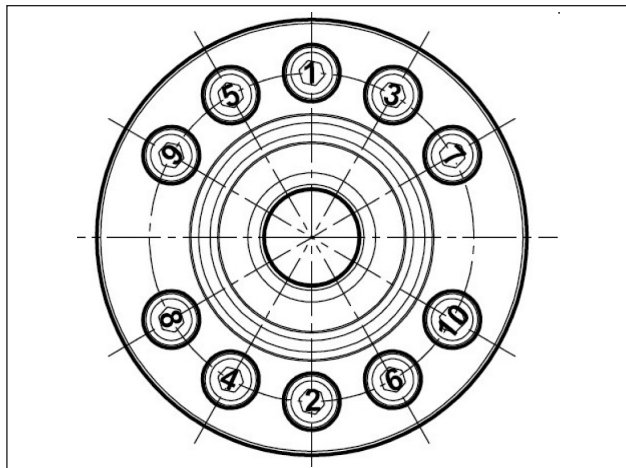

Fig. 49



Los tornillos -pos. 44 - 57- se deben apretar con la llave dinamométrica lubricando el pie roscado.

Apriete de los tornillos de la cabeza y las camisas

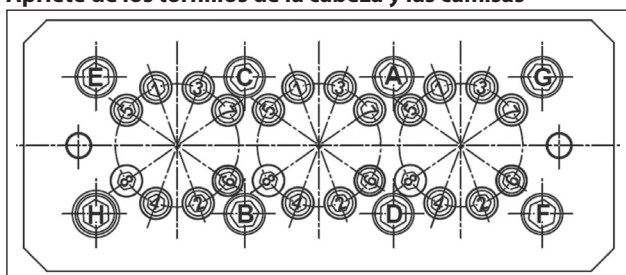

Fig. 50

OPERACIÓN 1: Apriete tornillos M12x260 (pos. 56) en dos fases respetando la secuencia indicada en la figura: (A-B-C-D-E-F-G-H)

Fase 1 = 40 Nm

Fase 2 = 80 Nm

OPERACIÓN 2: Apriete tornillos M8x100 (pos. 57) en cuatro fases respetando la secuencia indicada en la figura: (1-2-3-4-5-6-7-8)

Fase 1 = 20 Nm

Fase 2 = 30 Nm

Fase 3 = 35 Nm

Fase 4 = 35 Nm

4 SUSTITUCIÓN DEL CASQUILLO PIE DE LA BIELA

Durante la fase de mantenimiento si es necesario sustituir el casquillo pie de la biela y seguir las siguientes instrucciones:



Al extraer el casquillo desgastado prestar extrema atención a no dañar o rayar el alojamiento sobre la biela.

Realizar la conexión en frío del nuevo casquillo y durante tal operación asegurarse que:

- el orificio de lubricación coincida con el correspondiente orificio presente sobre la biela;
- el corte de unión sea orientado como se indica en Fig. 51.



A continuación realizar trabajos mecánicos respetando obligatoriamente las dimensiones y tolerancias mostradas en la Fig. 51.

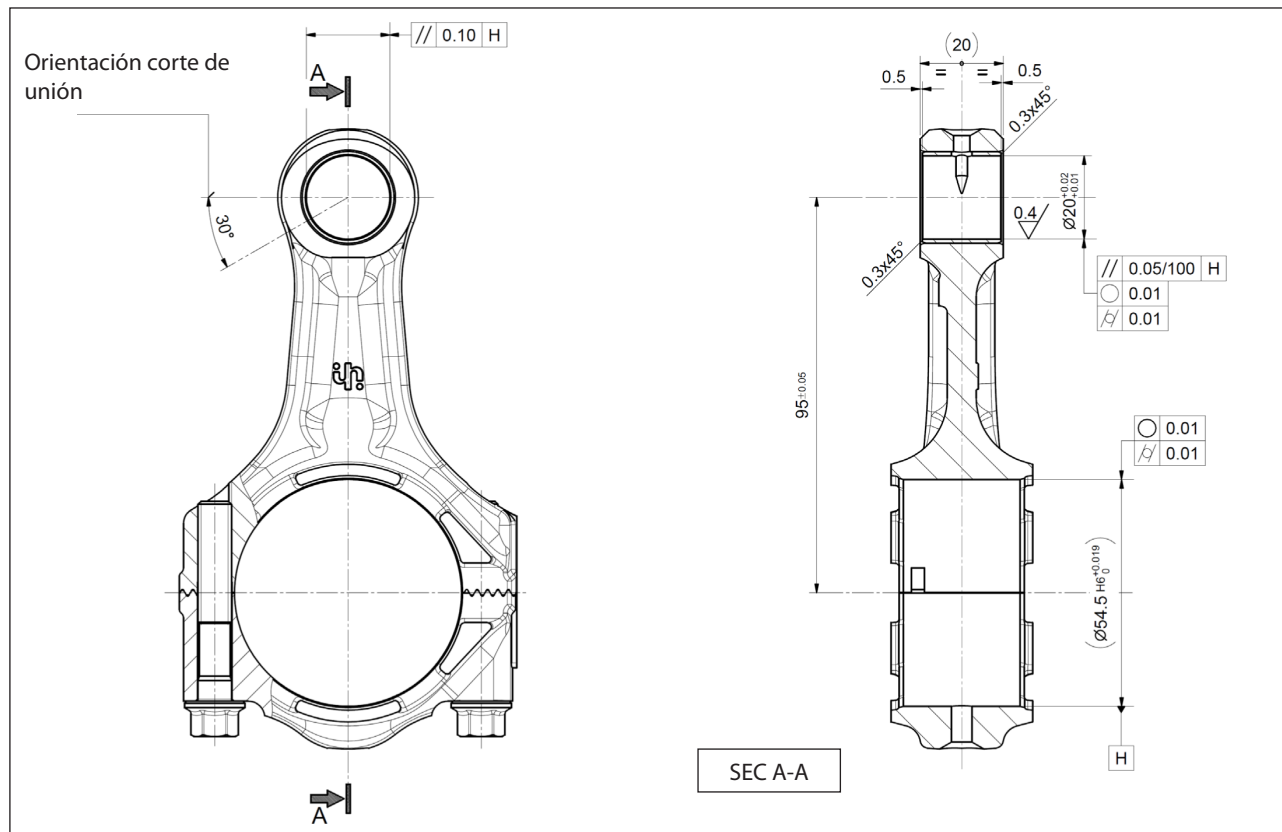

Fig. 51

5 HERRAMIENTAS DE REPARACIÓN

La reparación de la bomba puede ser facilitada utilizando herramientas codificadas:

Para las fases de montaje:

Casquillo de las juntas VF12; anillo de retención alternativa de H.P. Ø 12x24x13	cód. 27508400
	cód. 27365300
Casquillo de las juntas VF14; anillo de retención alternativa de H.P. Ø 14x24x13	cód. 27508400
	cód. 27365300
Columna de montaje de la cabeza (2 piezas)	cód. 27508200
Casquillo para pistón Ø12	cód. 27508300
Casquillo para pistón Ø14	cód. 27508500
Tampón para retención del eje de la bomba	cód. 27904800
Tampón para retención de la guía pistón	cód. 27904900

Para las fases de desmontaje:

Sedes de la válvula VF12 - VF14	cód. 27508000
Columna de montaje de la cabeza (2 piezas)	cód. 27508200
Retención guía pistón	cód. 27503900
	cód. 26019400

Resumo

1	INTRODUÇÃO	75
1.1	DESCRIÇÕES DOS SÍMBOLOS.....	75
2	NORMAS DE REPARAÇÃO	75
2.1	REPARAÇÃO DA PARTE MECÂNICA.....	75
2.1.1	<i>Desmontagem da parte mecânica</i>	75
2.1.2	<i>Remontagem da parte mecânica</i>	77
2.1.3	<i>Classes de deficiências previstas</i>	78
2.1.4	<i>Desmontagem/remontagem dos rolamentos e calços</i>	79
2.2	REPARAÇÃO DA PARTE HIDRÁULICA	80
2.2.1	<i>Desmontagem do cabeçote dos grupos da válvula</i>	80
2.2.2	<i>Remontagem do cabeçote - camisas - válvulas</i>	82
2.2.3	<i>Desmontagem do grupo do pistão - suportes - vedação</i>	82
2.2.4	<i>Remontagem do grupo do pistão - suportes - vedação</i>	84
3	CALIBRAGEM DO APERTO DOS PARAFUSOS	86
4	SUBSTITUIÇÃO DA BUCHA DO PÉ DA HASTE	88
5	FERRAMENTAS PARA A REPARAÇÃO	88

1 INTRODUÇÃO

Esse manual descreve as instruções para a reparação das bombas da família VF e deve ser atentamente lido e compreendido antes de realizar qualquer intervenção da bomba.

O uso correto e manutenção adequada depende do funcionamento e duração regular da bomba.

A Interpump Group não se responsabiliza por qualquer dano causado por mau uso ou pelo não cumprimento das regras descritas neste manual.

1.1 DESCRIÇÕES DOS SÍMBOLOS

Leia atentamente as instruções contidas neste manual antes de qualquer operação.



Sinal de Advertência



Leia atentamente as instruções contidas neste manual antes de qualquer operação.



Sinal de Perigo

Use óculos de proteção.



Sinal de Perigo

Use luvas de proteção antes de cada operação.

2 NORMAS DE REPARAÇÃO



2.1 REPARAÇÃO DA PARTE MECÂNICA

As operações de reparação da parte mecânica devem ser executadas depois de ter retirado o óleo do carter.

Para retirar o óleo, deve-se retirá-lo: a haste do nível do óleo pos. ①, e posteriormente a tampa pos. ②, Fig. 1.

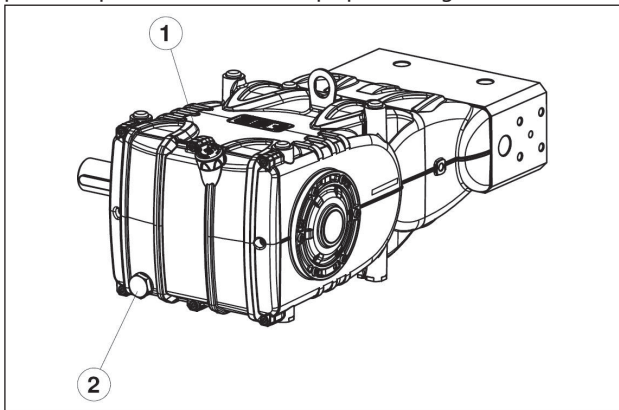

Fig. 1



O óleo esgotado deve ser colocado em um recipiente adequado e disposto em centrais adequadas.

Não deve ser, de forma nenhuma, disposto no meio ambiente.

2.1.1 Desmontagem da parte mecânica

As operações descritas são executadas depois de ter removido a parte hidráulica, os pistões de cerâmica e proteção contra respingos da bomba (parágs. 2.2.3, 2.2.4).

Para uma sequência correta, desmonte na seguinte ordem:

- a lingueta do eixo da bomba
- a cobertura posterior
- o chapéu da haste no seguinte modo: solte os parafusos de fixação do chapéu, extraia os chapéus da haste com os relativos semi-rolamentos inferiores (Fig. 2), prestando atenção na desmontagem da relativa sequência numerada.

Para evitar possíveis erros, os chapéus e as relativas baterias das hastes foram numerados na lateral (Fig. 2/a, pos. ①).

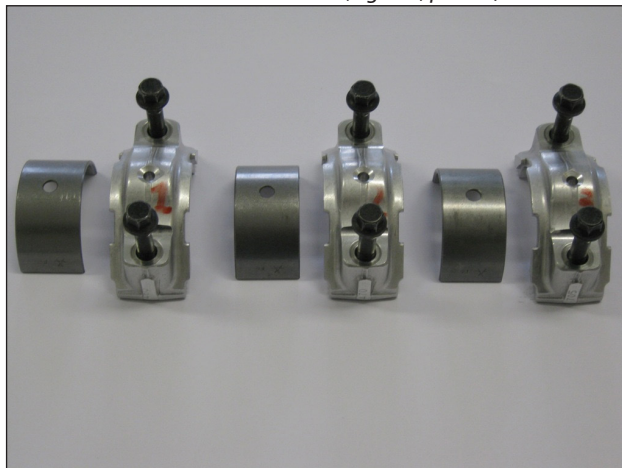

Fig. 2

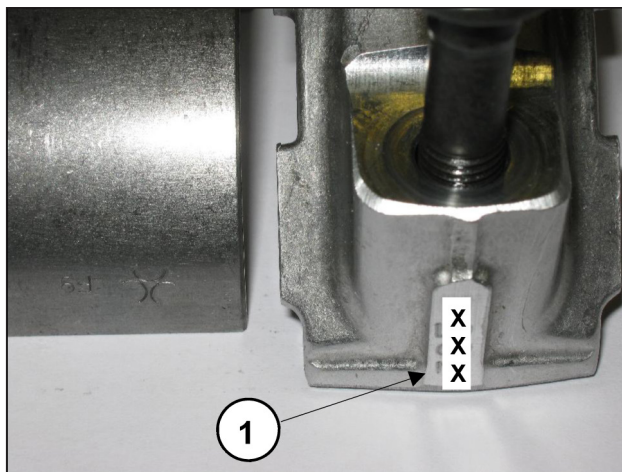

Fig. 2/a

- as coberturas laterais usando - para a extração - três parafusos M6x50 totalmente rosqueados, inserindo-os nos orifícios rosqueados, conforme indicado na Fig. 3.

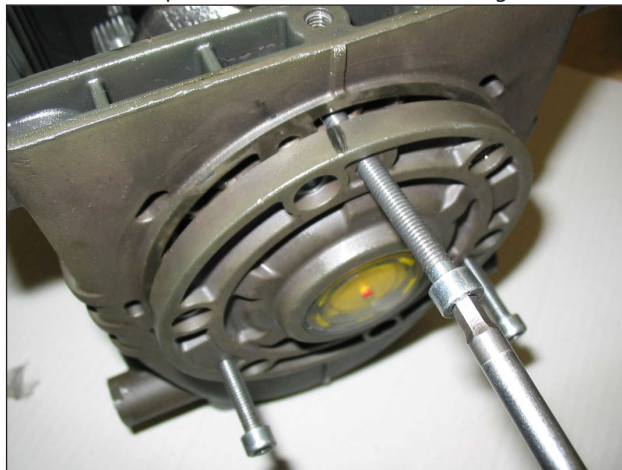

Fig. 3

- Pressione para frente as guias do pistão com as relativas hastes para facilitar a extração lateral do eixo da bomba. Sobre o eixo estão visíveis duas referências (indicados com o número 1 nas Fig. 4 e Fig. 4/a), e que devem estar voltados para o operador, de modo a facilitar a extração.

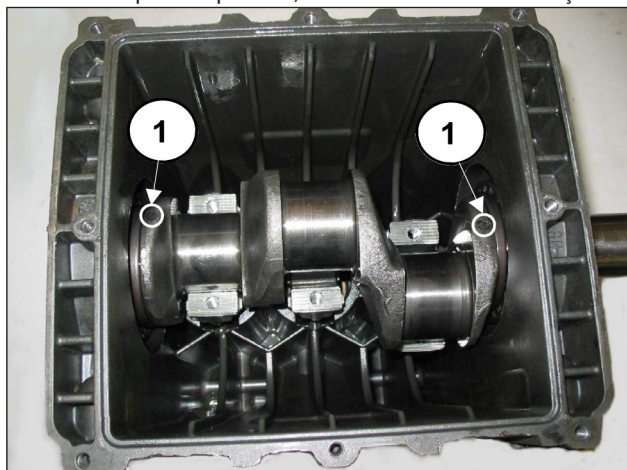

Fig. 4

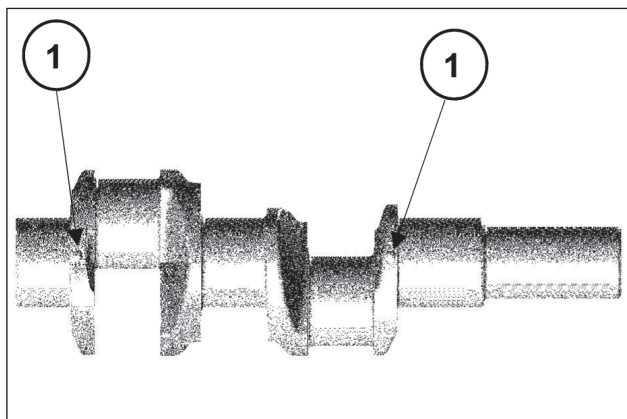

Fig. 4/a

- Extraia o eixo da bomba
- Conclua a desmontagem dos grupos da haste, extraindo-os do carter da bomba e removendo os pinos da guia do pistão.
- Desmonte os anéis de vedação do eixo da bomba com ferramentas comuns.
- Desmonte os anéis de vedação da guia do pistão, seguindo o procedimento descrito abaixo: use o extrator de cód. 26019400 (Fig. 5, pos. ①) e a pinça cód. 27503900 (Fig. 5, pos. ②). Insira a pinça até a parada do anel de vedação com o auxílio de um martelo (Fig. 5/a), em seguida, aperte o extrator na pinça e atue sobre o mecanismo de percussão do extrator (Fig. 5/b) até extrair o anel a ser substituído (Fig. 5/c).



Fig. 5/a



Fig. 5/b



Fig. 5/c

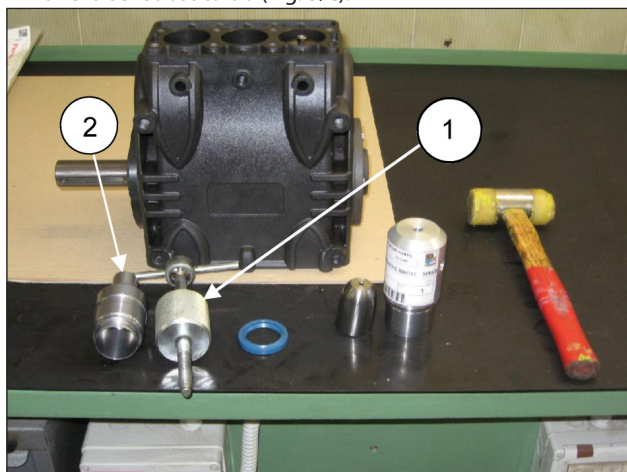

Fig. 5

2.1.2 Remontagem da parte mecânica

Depois de ter verificado a limpeza do carter, proceda com a montagem da parte mecânica, respeitando o procedimento descrito abaixo:



- Monte os semi-rolamentos superiores e inferiores nos respectivos assentos das hastes e dos chapéus.

Certifique-se de que as marcas de referência dos semi-rolamentos superiores (Fig. 6, pos. ①) e inferior (Fig. 6/a, pos. ②) são posicionados nos respectivos assentos da haste e do chapéu.

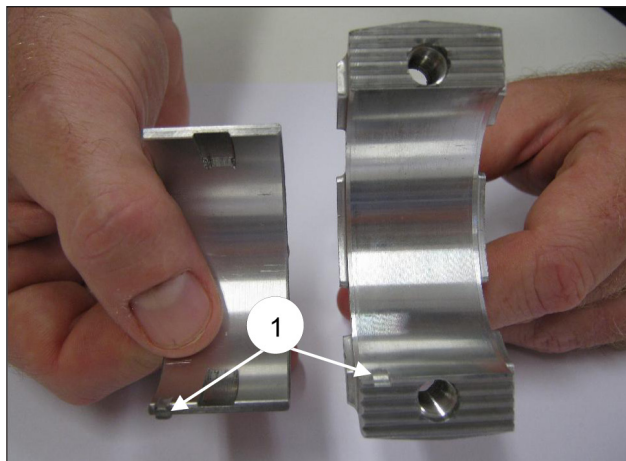

Fig. 6

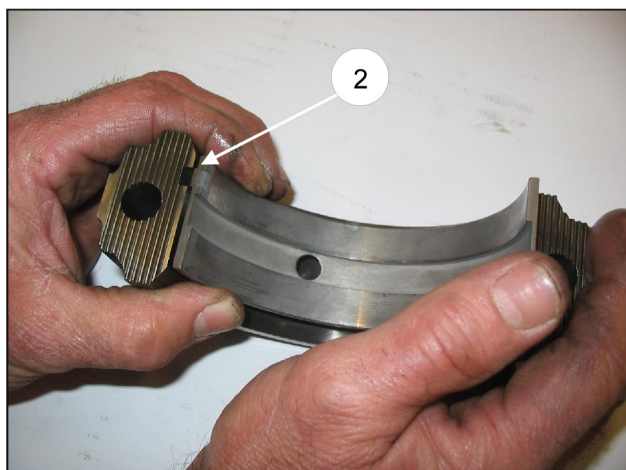

Fig. 6/a

- Introduza no carter da bomba os grupos da guia do pistão/haste, orientando a numeração presente no cilindro da haste para a parte superior do carter.

Para facilitar a introdução do eixo da bomba (sem separador), é indispensável repetir a operação realizada na desmontagem, empurrando, na parte inferior, os grupos da guia do pistão/haste (parág. 2.1.1).

- Antes de proceder com a montagem da cobertura lateral ao lado do PTO, verifique as condições da borda de vedação do anel radial e da zona de contato relativa no eixo.

Se for necessário substituir, posicione o novo anel usando a ferramenta (cód. 27904800), conforme indicado na Fig. 7.



Se o eixo da bomba apresenta um desgaste no diâmetro na área de contato com a borda de vedação, a fim de evitar a operação de correção, é possível reposicionar o anel em contato com a cobertura, conforme indicado na Fig. 7.

Antes de montar as coberturas laterais, certifique-se da presença dos anéis circulares de vedação em ambos os anéis de calço somente sobre a cobertura lateral da luz.

Para facilitar a entrada da primeira seção e da relativa inserção das coberturas no carter, aconselha-se o uso de três parafusos M6 x 40, parcialmente rosqueados, (Fig. 8, pos. ①) para depois completar a operação com os parafusos fornecidos (M6x18).

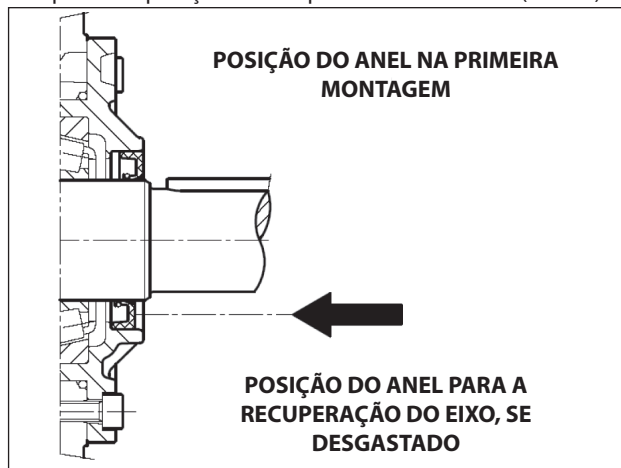

Fig. 7

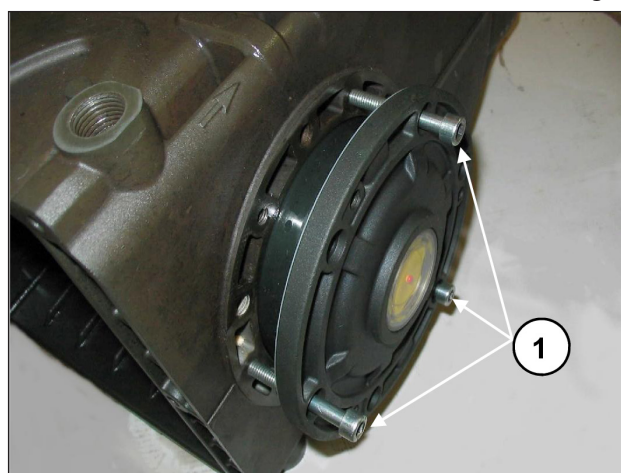

Fig. 8



- Emparelhe os chapéus da haste em suas relativas hastes, referindo-se à numeração (Fig. 9, pos. ①). **Preste atenção na direção correta da montagem dos chapéus.**

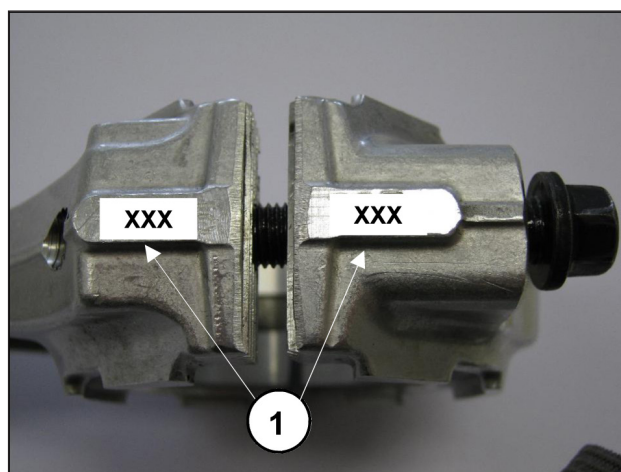

Fig. 9

- Fixe os chapéus aos respectivos cilindros da haste com os parafusos M8x1x48 (Fig. 10) lubrificando abaixo do cabeçote que tem a haste rosqueada, procedendo em duas fases diferentes:



1. **Execute manualmente o afrouxamento dos parafusos até o início do aperto**
 2. **Torque de aperto** **30 Nm**
- Alternativamente, execute:**
1. **Torque de pré-aperto** **10-15 Nm**
 2. **Torque de aperto** **30 Nm**



Fig. 10

- Depois de ter concluído a operação de aperto, verifique se o cabeçote da haste tem uma folga lateral nas duas direções.
- Monte os novos anéis de vedação da guia do pistão até a parada com o relativo local no carter da bomba (Fig. 11), seguindo o procedimento descrito a seguir: use a ferramenta de cód. 27904900, composta de bússola cônica e tampão. Solte a bússola cônica no furo presente na guia do pistão (Fig. 11/a), insira o novo anel de vedação no tampão e traga-o até a parada (determinada pela altura do mesmo tampão) no próprio local no carter da bomba (Fig. 11/b), retire a bússola cônica (Fig. 11/c).

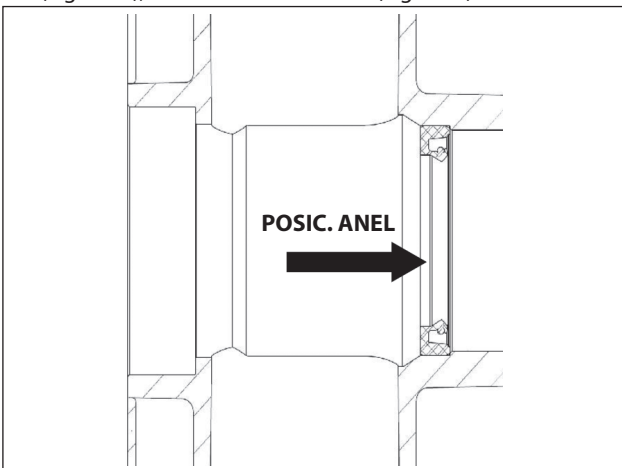

Fig. 11

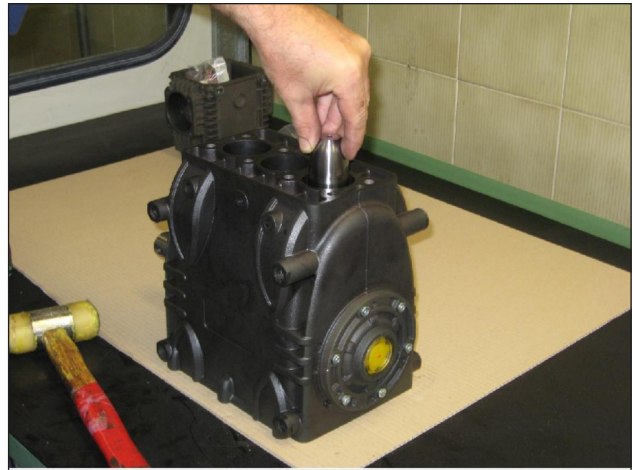

Fig. 11/a



Fig. 11/b



Fig. 11/c

- Monte a cobertura posterior completa do anel circular de vedação, posicionando o furo da haste do nível de óleo para cima.
- Insira o óleo no carter conforme indicado no **Manual de uso e manutenção**.

2.1.3 Classes de deficiências previstas

TABELA DE DEFICIÊNCIAS PARA O EIXO DE MANIVELAS E SEMI-ROLAMENTOS DA HASTE			
Classe de recuperação (mm)	Código do semi-rolamento superior	Código do semi-rolamento inferior	Correção do diâmetro da articulação do eixo (mm)
0.25	90924100	90924400	Ø49.75 0/-0.02 Ra 0.4 Rt 3.5
0.50	90924200	90824500	Ø49.50 0/-0.02 Ra 0.4 Rt 3.5

2.1.4 Desmontagem/remontagem dos rolamentos e calços

O tipo de rolamento (os rolos cônicos) garante a ausência do jogo axial do eixo da manivela, os calços são definidos para atingir este objetivo. Para a desmontagem/remontagem e para eventuais substituições deve-se seguir atentamente as indicações a seguir:

A) Desmontagem/remontagem do eixo da manivela sem substituição dos rolamentos

Depois de desmontar as coberturas laterais, conforme indicado no parág. 2.1.1, verifique o estado dos rolos e das inclinações relativas. Se todas as partes forem consideradas como idôneas, limpe cuidadosamente os componentes com o desengordurante adequado e redistribua uniformemente o óleo lubrificante.

Pode ser reutilizado as espessuras anteriores prestando atenção ao inseri-las somente sob a cobertura lateral da luz. Monte o grupo completo (flange lateral da luz + eixo + flange lateral do motor) e aperte os parafusos das coberturas com o torque especificado, verificando se o torque do rolamento do eixo da haste não conectada cai em um valor entre 4 e 6 Nm. Para a aproximação das duas coberturas laterais ao carter, pode ser usado três parafusos M6x40 para uma primeira fase de orientação, conforme indicado acima, e os parafusos previstos para a fixação final.

O torque de rolamento do eixo com as hastes ligadas não deve superar o valor de 8 Nm.

B) Desmontagem/Remontagem do eixo de manivela com substituição dos rolamentos

Depois de ter desmontado as coberturas laterais, conforme indicado acima, remova o anel externo dos rolamentos das respectivas ranhuras nas coberturas, usando um extrator adequado, conforme indicado nas Fig. 12 e Fig. 12/a. Remova o anel interno dos rolamentos das duas extremidades do eixo, sempre usando um extrator adequado ou, em alternativa, uma simples "perfuração", conforme indicado na Fig. 13.



Fig. 12



Fig. 12/a



Fig. 13

Os novos rolamentos podem ser montados a frio com uma prensa ou barra, apoiando-os necessariamente na superfície lateral do anel em questão nos eixos com anéis especiais. A operação de martelar pode ser facilitada, aquecendo as partes interessadas a uma temperatura entre 120° - 150°C (250° - 300°F), certificando-se de que os anéis vão com bastão em seus respectivos assentos.



Nunca misture as partes dos dois rolamentos.

Determinação do pacote dos calços:

Execute a operação com grupos da guia do pistão-haste montados, chapéus da haste desconectados e haste puxada para baixo. Insira o eixo da bomba com nenhuma lingueta no carter, certificando-se de que a haste PTO sai do lado esperado.

Fixe a flange lateral do PTO ao carter, prestando a máxima atenção à borda do anel de vedação, de acordo com o procedimento descrito acima, e aperte os parafusos de fixação com o torque previsto.

Em seguida, adote a flange ao lado da luz sem espessura no carter e comece a aproximá-la, apertando os parafusos de serviço M6x40 manualmente, de modo relativamente justo, com pequenas rotações que geram um avanço lento e correto da cobertura.

Simultaneamente, verifique se o eixo gira livremente, girando-o manualmente.

Continuando o procedimento desta forma, se sentirá um aumento súbito da dureza na rotação do eixo.

Neste ponto, interrompa o avanço da cobertura e solte os parafusos de fixação completamente.

Com a ajuda de um medidor de espessura, detecte a folga entre a cobertura lateral e o carter da bomba (ver Fig. 14).



Fig. 14

Continue para determinar o pacote das espessuras, usando a tabela abaixo:

Medida detectada	Tipo de espessura	Nº de peças
De: 0,05 a: 0,10	/	/
De: 0,11 a: 0,20	0,1	1
De: 0,21 a: 0,30	0,1	2
De: 0,31 a: 0,35	0,25	1
De: 0,36 a: 0,45	0,35	1
De: 0,46 a: 0,55	0,35 0,10	1 1
De: 0,56 a: 0,60	0,25	2
De: 0,61 a: 0,70	0,35 0,25	1 1



Fig. 15

Determinado pela tabela o tipo e o número de espessuras, efetue o seguinte controle: monte o pacote de espessuras no centro da cobertura lateral da luz (Fig. 15), fixe a cobertura no carter, seguindo o procedimento do parág. 2.1.2, aperte os respectivos parafusos com o torque previsto.

Verifique se o torque resistente de rotação do eixo cai em um valor entre 4 Nm e 6 Nm.

Se tal torque está correto, efetue uma ligação das hastes do eixo para o eixo das manivelas e para as fases seguintes, caso contrário, redefina o conjunto de espessuras, repetindo as operações.

2.2 REPARAÇÃO DA PARTE HIDRÁULICA

2.2.1 Desmontagem do cabeçote dos grupos da válvula

O cabeçote não precisa de manutenção periódica.

As intervenções são limitadas à inspeção ou substituição da válvula, quando necessário.

Para a extração dos grupos da válvula, opere como mostra a seguir:

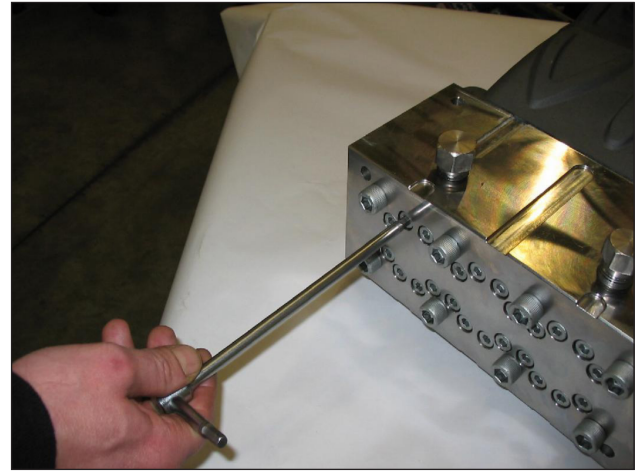

Fig. 16



- Solte, sem remover, os parafusos M8x100 de fixação das camisas no cabeçote, conforme indicado na Fig. 16, de modo a deixá-los livres.

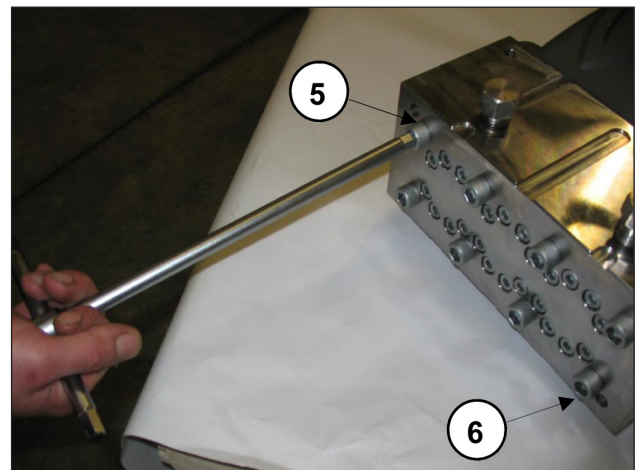

Fig. 17

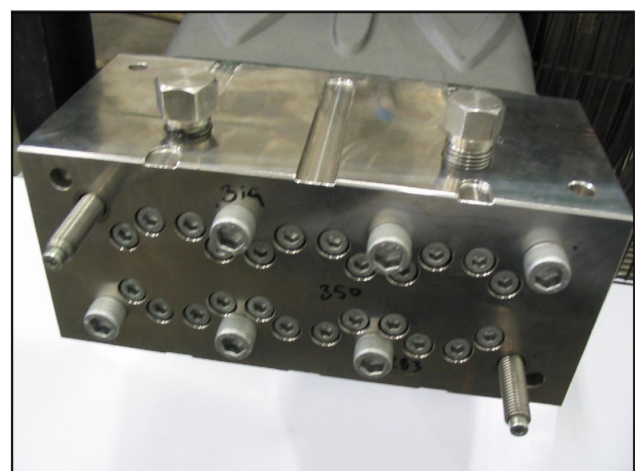

Fig. 18

- Solte os parafusos de fixação do cabeçote M12x260 n° 5 e n° 6, conforme indicado na Fig. 17, substituindo-o por dois parafusos-tomadas de serviço (cód. 27508200), conforme indicado na Fig. 18. Em seguida, proceda com a remoção dos parafusos restantes.



Fig. 19

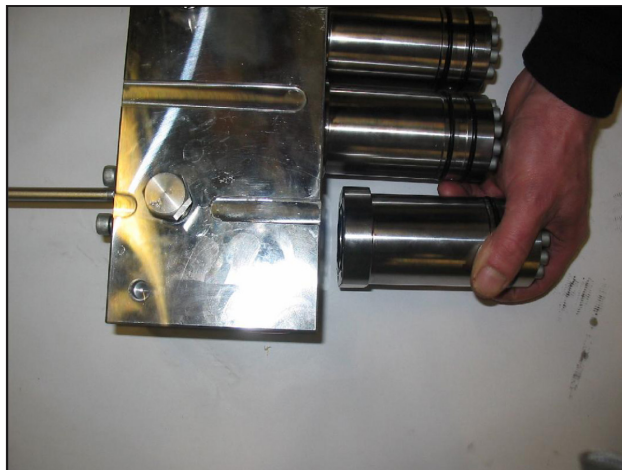

Fig. 22

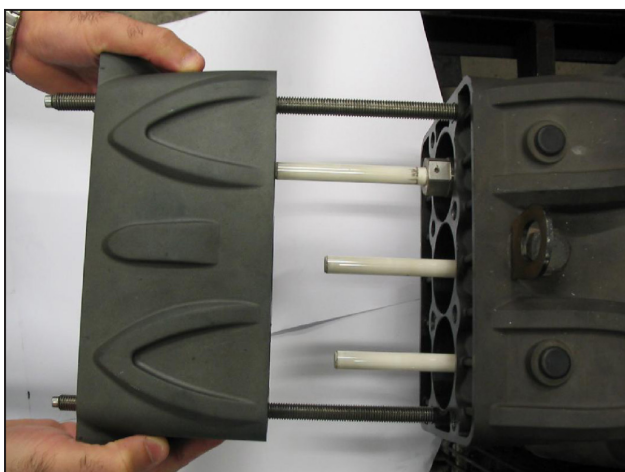

Fig. 20

- Separe o cabeçote e o espaçador para camisas do carter da bomba, conforme indicado nas Fig. 19 e Fig. 20.



Fig. 21

- Remova os parafusos M8x100 de fixação das camisas no cabeçote, conforme indicado na Fig. 21 e proceda conforme indicado na Fig. 22.

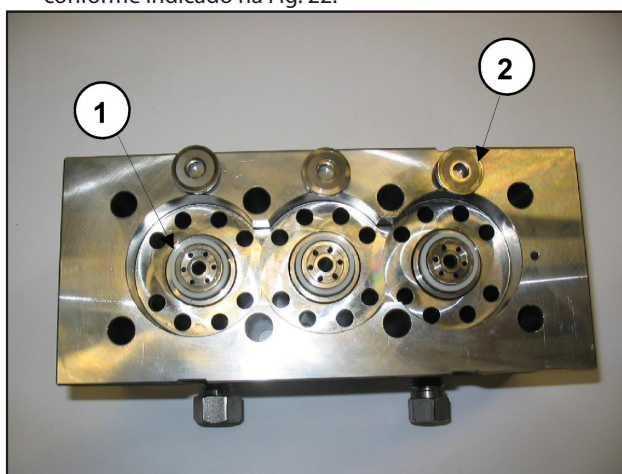

Fig. 23



Durante a desmontagem das camisas, preste atenção para não dispersar os locais da válvula ① e as válvulas planas ②, conforme indicado na Fig. 23, os quais estão sendo posicionados somente na parada, podendo cair.

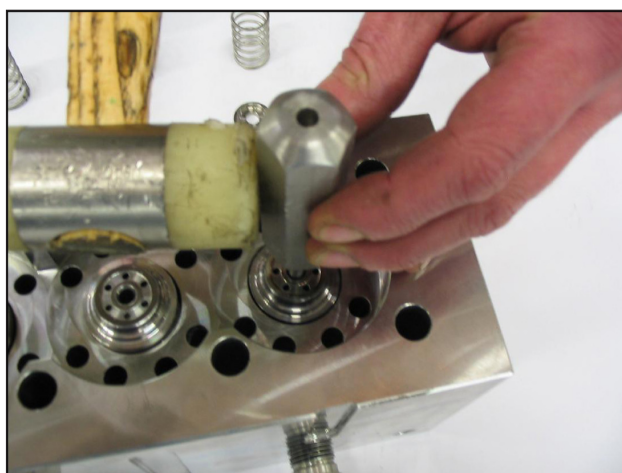

Fig. 24



Se os locais da válvula se revelarem bloqueados sobre o cabeçote devido à formação de dimensão ou de óxido, deve ser desbloqueado, inserindo a ferramenta adequada (cód. 27508000 "VF12" - "VF14") no furo de aspiração, operando conforme a Fig. 24.

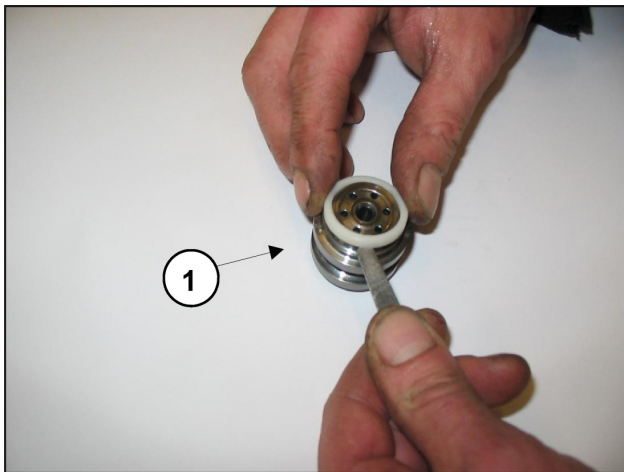

Fig. 25

- Extraia os locais da válvula ①, conforme indicado na Fig. 25, verifique o estado de desgaste dos vários componentes e, se necessário, execute eventuais substituições.



A cada inspeção da válvula, substitua sempre todos os anéis de vedação e os relativos anéis circulares de vedação frontal entre a camisa e o cabeçote, entre o cabeçote e o espaçador de camisa da zona do furo de recirculação.

Antes de remontar, limpe e enxugue os vários componentes e todas as relativas ranhuras no interior do cabeçote.

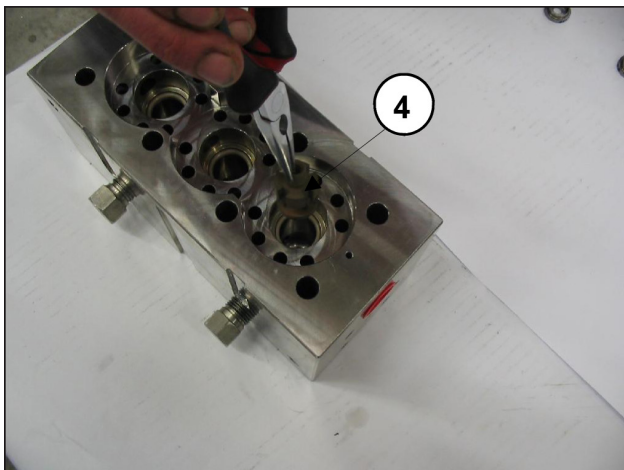

Fig. 26

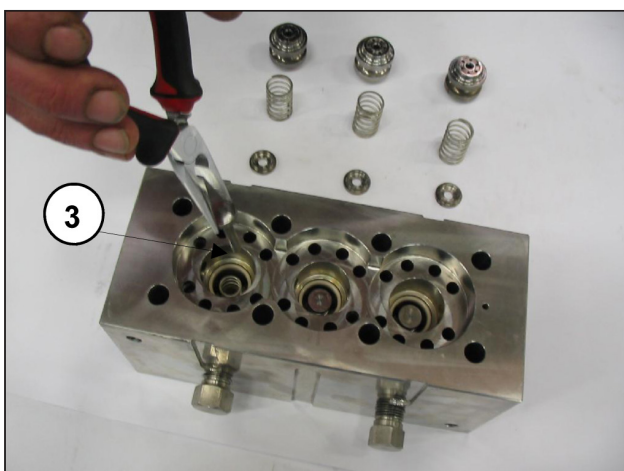

Fig. 27

- Extraia as placas de fluxo ③ e as respectivas guias ④ com as relativas molas, conforme indicado nas Fig. 26 e Fig. 27, verifique o seu estado de desgaste e efetue, se necessário, eventuais substituições, e no entanto, nos intervalos indicados na tabela "MANUTENÇÃO PREVENTIVA", do capítulo 11 do *Manual de uso e manutenção*.

2.2.2 Remontagem do cabeçote - camisas - válvulas



Para remontar os vários componentes, inverta as operações listadas anteriormente com especial atenção para a montagem correta do espaçador para as camisas: as duas descargas aproximadas de fusão presentes em um dos dois lados, montadas especialmente devem ser orientadas para a parte inferior do carter (lateral de aberto da bomba).

Cabeçote - camisa: proceda com a montagem e a calibragem dos parafusos de fixação do cabeçote e depois, proceda com a calibragem dos parafusos de fixação das camisas.

Para os valores do torque de aperto e as várias fases, respeite as indicações relacionadas no capítulo 3.

2.2.3 Desmontagem do grupo do pistão - suportes - vedação

O grupo de pistão não precisa de manutenção periódica. As intervenções são limitadas somente ao controle visual de drenagem do circuito de resfriamento. Se for apresentado falhas/oscilações no manômetro de fluxo ou pulsações do tubo de drenagem do circuito de resfriamento (se elástico), será necessário proceder com o controle e com eventual substituição do pacote de vedação.

Para a extração dos grupos do pistão, opere conforme a seguir.

- Separe o cabeçote e o espaçador para camisas do carter da bomba, conforme indicado no pará. 2.2.1 (Fig. 19, Fig. 20).

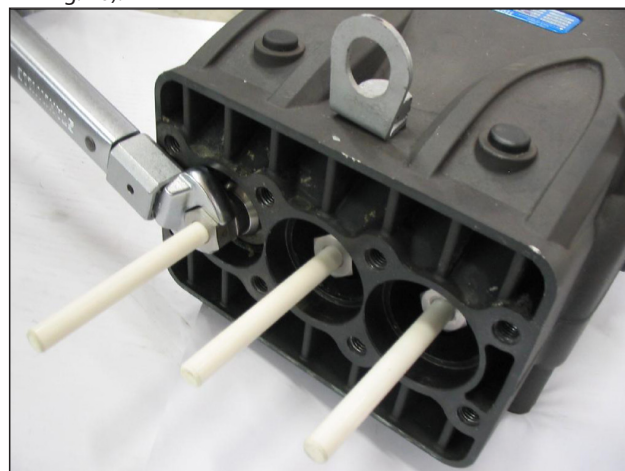

Fig. 28

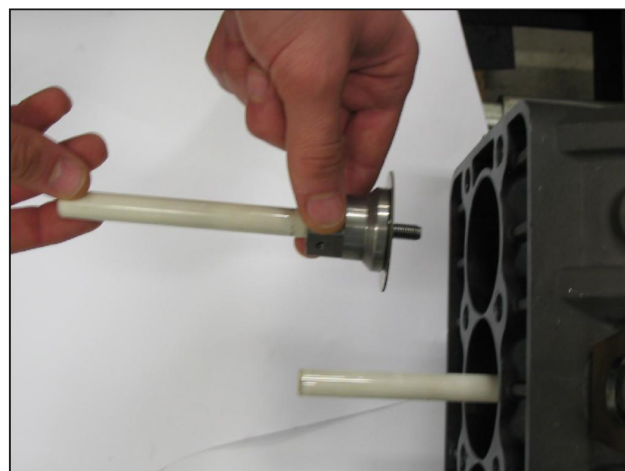

Fig. 29

- Remova os pistões com uma chave de boca e verifique o seu estado de desgaste, conforme indicado nas Fig. 28 e Fig. 29, substituindo-os, se necessário.
- Remova os parafusos M6x40 de fixação do suporte da camisa, conforme indicado na Fig. 30, e proceda com a separação do suporte, conforme indicado na Fig. 31.



Fig. 30

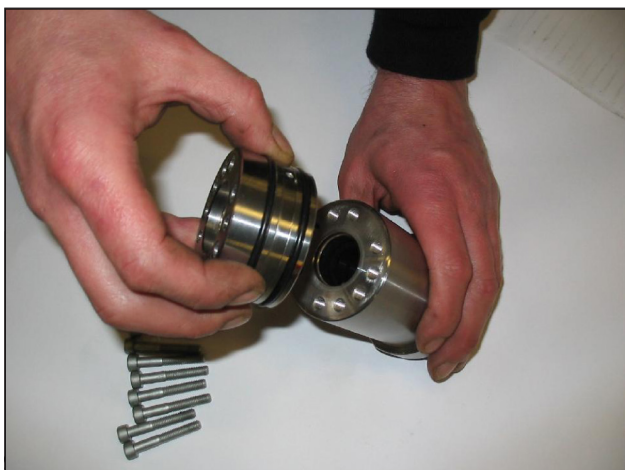

Fig. 31

- Remova o anel de Seeger e o anel de retenção da vedação, conforme indicado na Fig. 32, e com um pino especial em material plástico, extraia a vedação do LP (baixa pressão) ① conforme indicado na Fig. 33.



Fig. 32

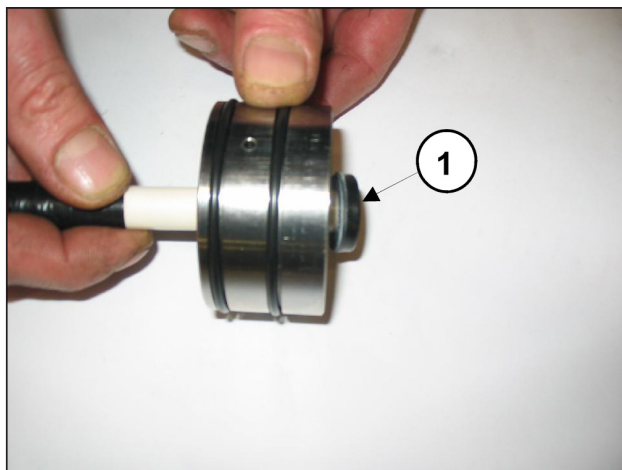

Fig. 33



A cada desmontagem, as vedações de baixa pressão deverão ser substituídas, como também todos os anéis circulares.

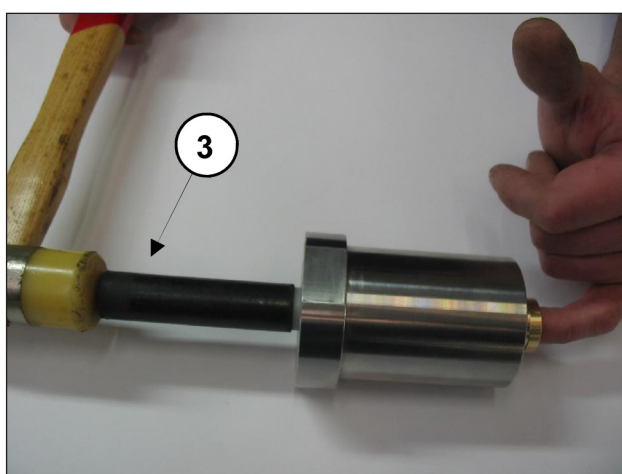

Fig. 34

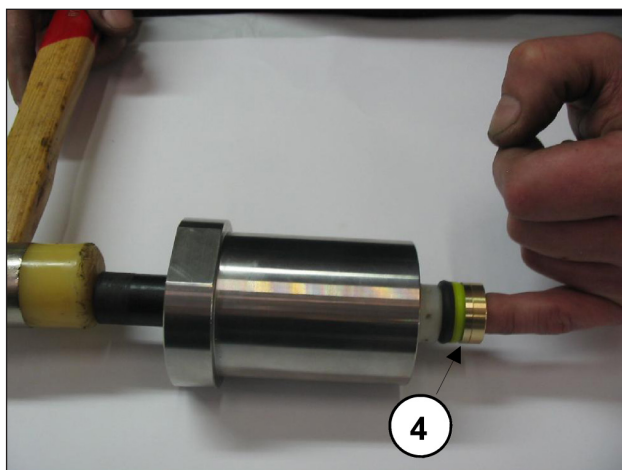

Fig. 35

- Com a camisa separada do suporte de vedação e com um pino especial em material plástico, ③ conforme indicado na Fig. 34, faça esvaziar o pacote do HP (alta pressão) ④ operando como na Fig. 35.



A cada desmontagem, o pacote do HP (Fig. 31, pos. ④) deverá ser substituído.

2.2.4 Remontagem do grupo do pistão - suportes - vedação

Para a remontagem dos vários componentes, inverta as operações descritas anteriormente, prestando particular atenção às várias sequências listadas acima; para os valores do torque de aperto e as várias fases, respeite as indicações relacionadas no capítulo 3.

- Insira a bússola superior na camisa.



Fig. 36



Fig. 37



Para um posicionamento axial correto da bússola, use a ferramenta especial (cód. 27508300, válida para bombas do tipo VF12 e cód. 27508500, válido para bombas do tipo VF14), conforme indicado nas Fig. 36 e Fig. 37.



Fig. 38

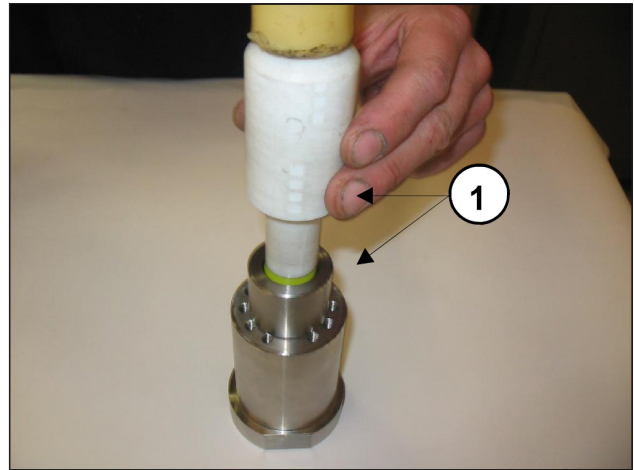

Fig. 39

- Introduza o pacote do H.P. (alta pressão), dada a pequena interferência entre a vedação e a camisa para evitar eventuais danos, aconselha-se o uso da ferramenta indicada nas Fig. 38 e Fig. 39 pos. ① (cód. 27508400 e cód. 27365300).

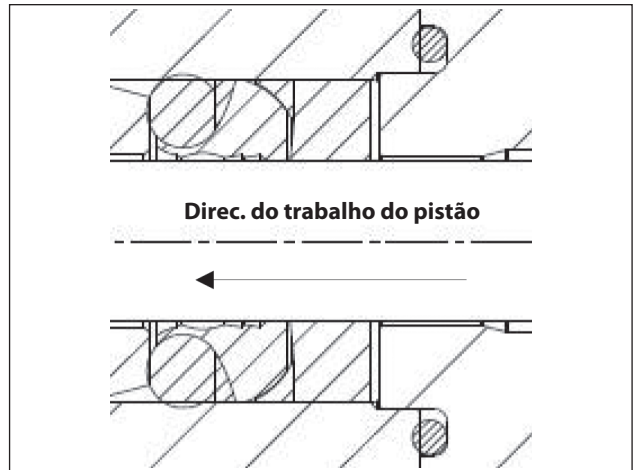

Fig. 40

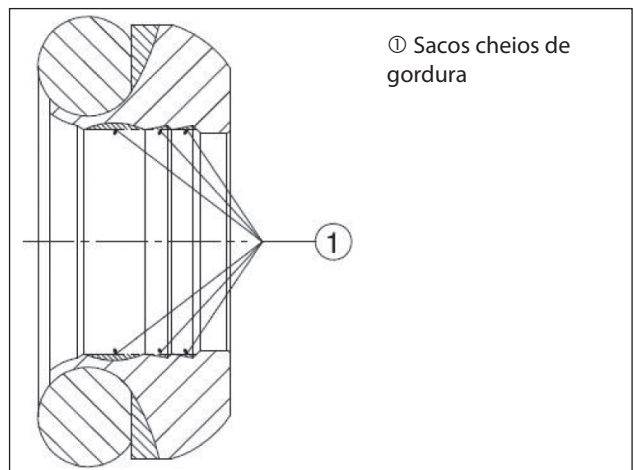

Fig. 40/a



A vedação do H.P. deve ser introduzida na camisa com o anel circular com energização da vedação na direção de trabalho do pistão, conforme indicado nas Fig. 38 e Fig. 40.



Antes da montagem nos locais da vedação de H.P. devem ser lubrificadas com lubrificante de silicone OK S1110, siga as operações listadas abaixo:

- A) O diâmetro externo deve resultar somente ligeiramente lubrificado;
- B) No diâmetro interno, o lubrificante deve ser aplicado com cuidado especial para o preenchimento de todos os sacos entre as bordas de vedação, conforme indicado na Fig. 40/a.

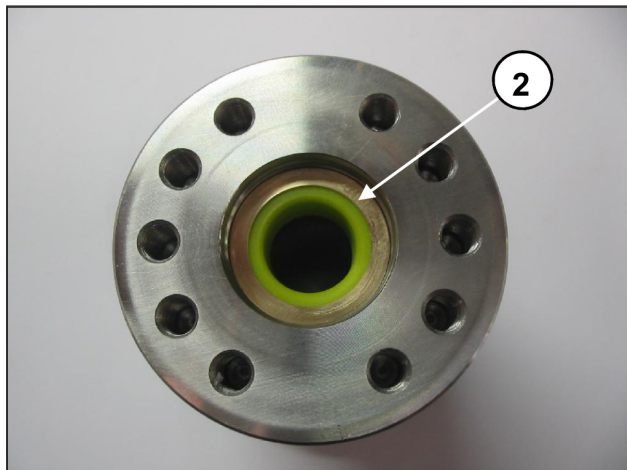

Fig. 41

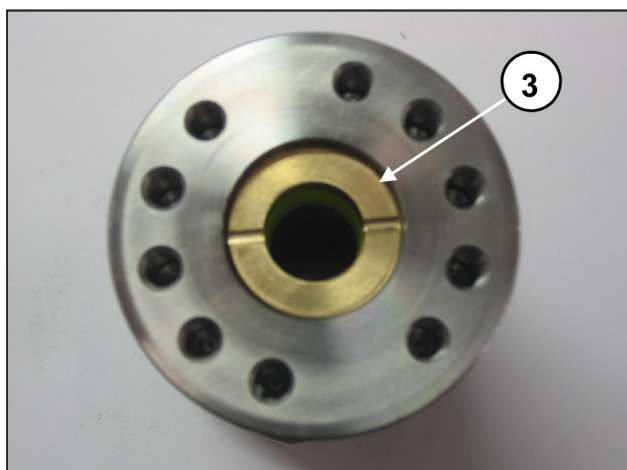

Fig. 42

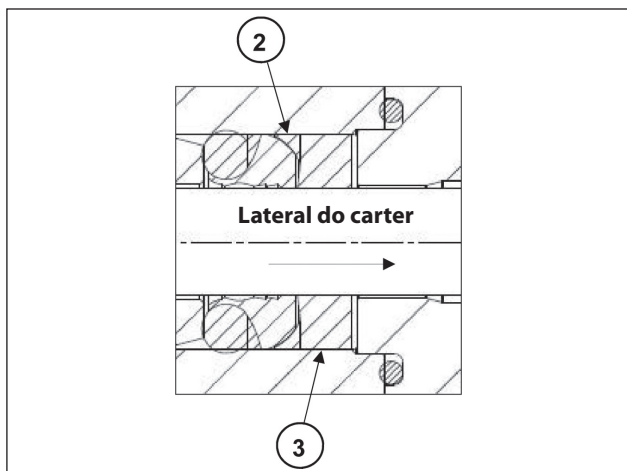

Fig. 43

- Introduza o anel anti-extrusão ② e a bússola de vedação ③ posicionados, conforme as Fig. 41, Fig. 42, Fig. 43.



A bússola das vedações ③ deve ser introduzida na camisa com as descargas viradas para o exterior (lateral do carter), conforme indicado nas Fig. 42 e in Fig. 43.



A vedação do L.P. deve ser introduzida na camisa com a borda de vedação na direção de trabalho do pistão, conforme indicado nas Fig. 44 e Fig. 45, lubrificando ligeiramente o diâmetro externo com lubrificante de silicone do tipo OKS 1110.

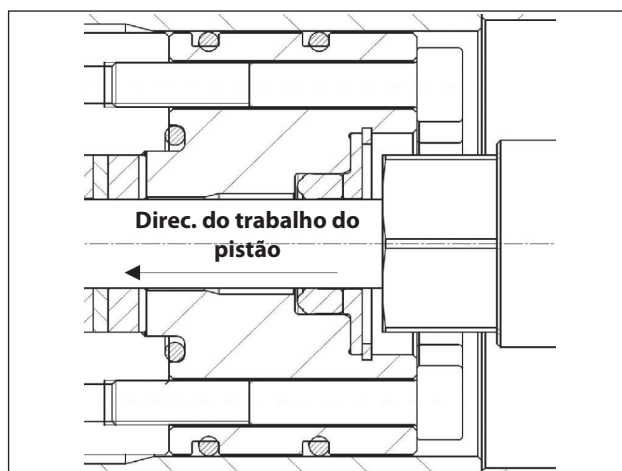

Fig. 44



Fig. 45

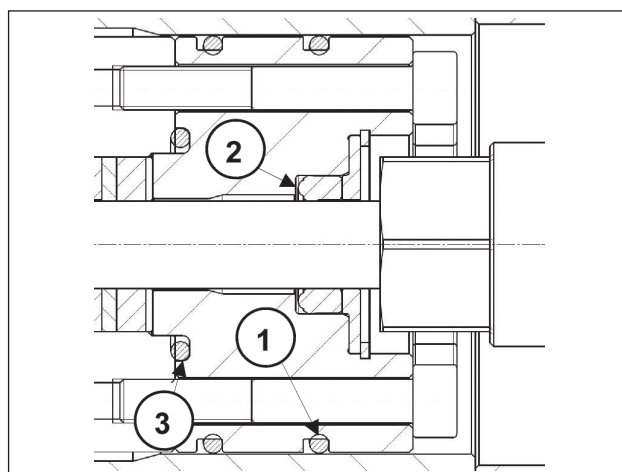

Fig. 46

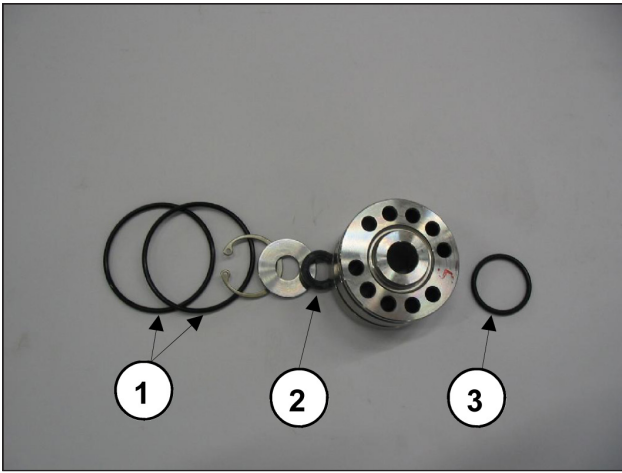

Fig. 47

- Remonte o grupo de suporte da vedação, conforme indicado nas Fig. 46 e Fig. 47, substituindo os componentes ①②③.



Fig. 48

- Monte o grupo de suporte - camisa soltando manualmente os parafusos M6x40, conforme indicado na Fig. 48. Em seguida, proceda com a calibragem com chave dinamométrica, conforme indicado no capítulo 3.

3 CALIBRAGEM DO APERTO DOS PARAFUSOS

O aperto dos parafusos é para ser executado exclusivamente com chave dinamométrica.

Descrição	Posic. de explosão	Torque de aperto Nm
Parafuso de fixação das coberturas	9	10
Tampa da descarga do óleo	11	40
Parafuso de fixação do suporte de elevação	17	40
Parafuso de fixação do chapéu da haste	16	30*
Fixação dos pistões	28	20
Encaixe do bloqueador	31	10
Parafuso de fixação dos suportes	44	15****
Parafuso de fixação do cabeçote	57	80**
Parafuso de fixação da camisa	56	35***
Parafuso da flange do motor hidráulico	64	40

* Os parafusos de fixação do chapéu da haste devem ser apertados, respeitando as fases indicadas na pag. 78.

** Os parafusos de fixação do cabeçote devem ser apertados, respeitando as fases e a ordem relacionada no esquema da Fig. 50.

*** Os parafusos de fixação das camisas devem ser apertadas, respeitando as fases e a ordem relacionada no esquema da Fig. 50.

**** Os parafusos de fixação dos suportes devem ser apertados em uma única fase, respeitando a ordem relacionada no esquema da Fig. 49.

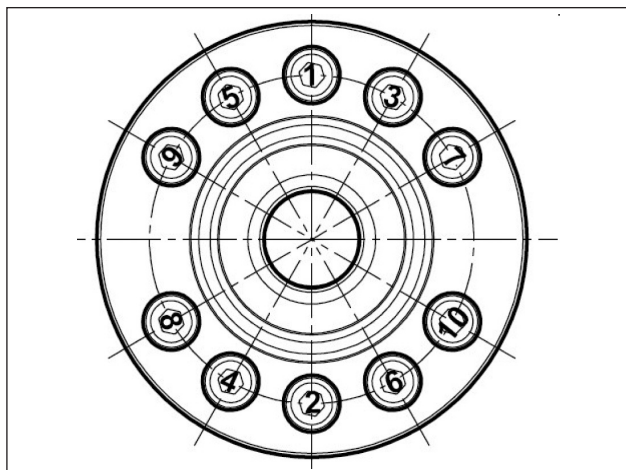

Fig. 49



Os parafusos - pos. 44-57 - devem ser apertados com chave dinamométrica, lubrificando a haste rosqueada.

Aperto dos parafusos do cabeçote e da camisa

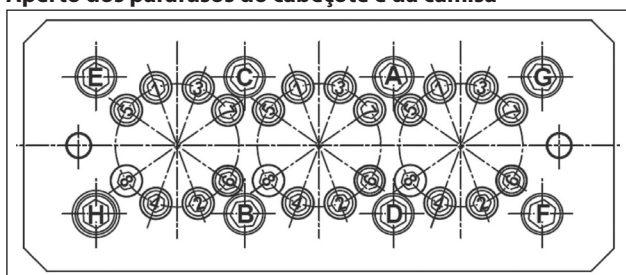

Fig. 50

OPERAÇÃO 1: Aperto dos parafusos M12x260 (pos. 56) em duas fases respeitando a sequência indicada na figura: (A-B-C-D-E-F-G-H)

Fase 1 = 40 Nm

Fase 2 = 80 Nm

OPERAÇÃO 2: Aperto dos parafusos M8x100 (pos. 57) em quatro fases, respeitando a sequência indicada na figura: (1-2-3-4-5-6-7-8)

Fase 1 = 20 Nm

Fase 2 = 30 Nm

Fase 3 = 35 Nm

Fase 4 = 35 Nm

4 SUBSTITUIÇÃO DA BUCHA DO PÉ DA HASTE

Em fase de manutenção, se for necessário, substituir a bucha do pé da haste prestando atenção às seguintes indicações:



Ao retirar a bucha desgastada, ser extremamente cuidadoso para não danificar ou arranhar a habitação da haste.

Execute o martelamento a frio da nova bucha, durante tal operação certifique-se de que:

- o furo de lubrificação coincide com o furo correspondente presente na haste;
- o corte de junção é orientado, conforme indicado na Fig. 51.



Execute sucessivamente os trabalhos mecânicos, respeitando rigorosamente as dimensões e tolerâncias relacionadas na Fig. 51.

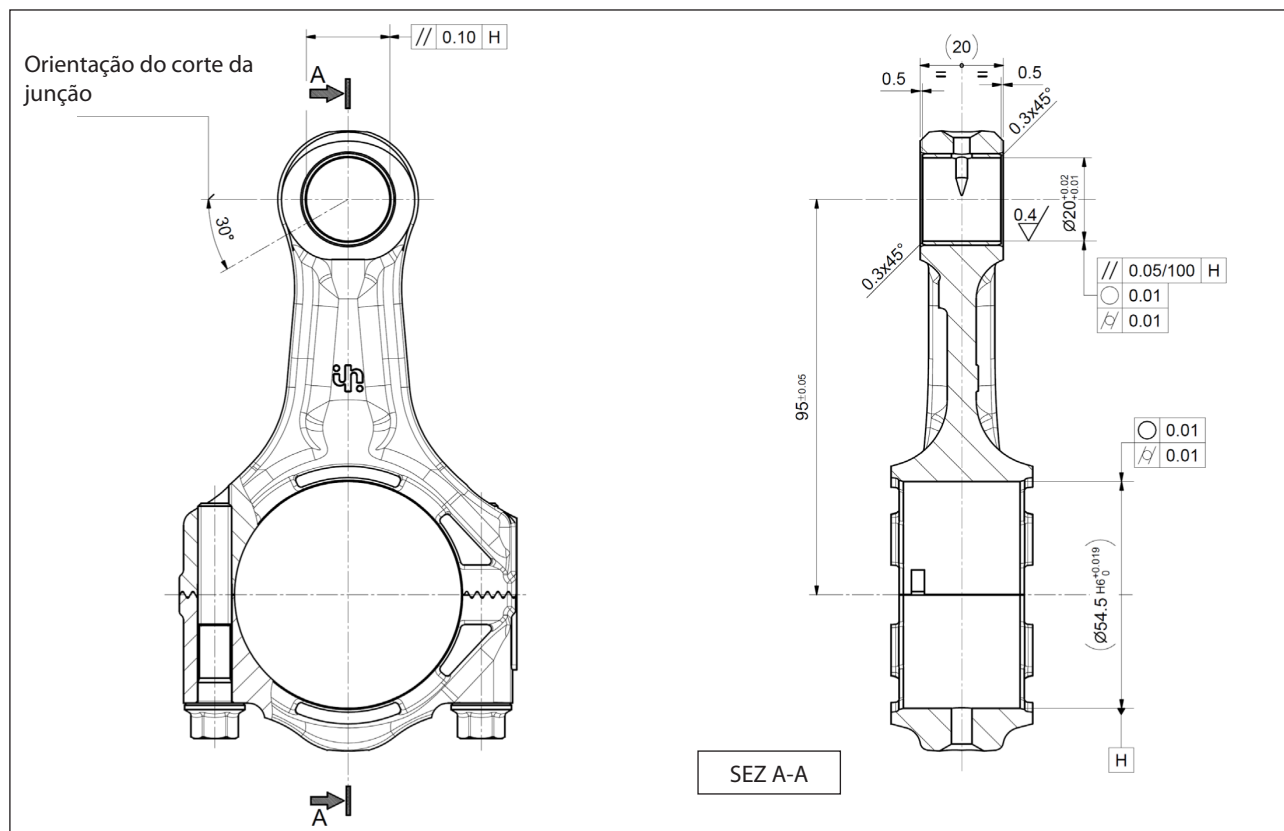

Fig. 51

5 FERRAMENTAS PARA A REPARAÇÃO

A reparação da bomba pode ser facilitada através de ferramentas adequadas após serem codificadas:

Para as fases de montagem:

Bússola das vedações VF12; anel de vedação alternativa do H.P. Ø 12x24x13	cód. 27508400
	cód. 27365300
Bússola das vedações VF14; anel de vedação alternativa do H.P. Ø 14x24x13	cód. 27508400
	cód. 27365300
Pino de montagem do cabeçote (duas peças)	cód. 27508200
Bússola para pistão Ø12	cód. 27508300
Bússola para pistão Ø14	cód. 27508500
Tampão para a vedação do eixo da bomba	cód. 27904800
Tampão para a vedação da guia de pistão	cód. 27904900

Para as fases de desmontagem:

Locais da válvula VF12 - VF14	cód. 27508000
Pino de montagem do cabeçote (duas peças)	cód. 27508200
Vedações do óleo da guia do pistão	cód. 27503900
	cód. 26019400

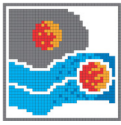

Pratissoli

Copyright di queste istruzioni operative è di proprietà di Interpump Group.

Le istruzioni contengono descrizioni tecniche ed illustrazioni che non possono essere elettronicamente copiate e neppure riprodotte interamente od in parte né passate a terzi in qualsiasi forma e comunque senza l'autorizzazione scritta dalla proprietà. I trasgressori saranno perseguiti a norma di legge con azioni appropriate.

Copyright of these operating instructions is property of Interpump Group.

The instructions contain technical descriptions and illustrations which may not be entirely or in part copied or reproduced electronically or passed to third parties in any form and in any case without written permission from the owner. Violators will be prosecuted according to law with appropriate legal action.

D'après les lois de Copyright, ces instructions d'utilisation appartiennent à Interpump Group.

Les instructions contiennent des descriptions techniques et des illustrations qui ne peuvent être ni copiées ni reproduites par procédé électronique, dans leur intégralité ou en partie, ni confiées à des tiers sous quelque forme que ce soit, en l'absence de l'autorisation écrite du propriétaire. Les transgresseurs seront poursuivis et punis par la loi.

Copyright-Inhaber dieser Betriebsanleitung ist Interpump Group.

Die Anleitung enthält technische Beschreibungen und Abbildungen, die nur mit vorheriger schriftlicher Genehmigung des Copyright-Inhabers elektronisch kopiert, zur Gänze oder teilweise reproduziert oder in jeglicher Form an Dritte weitergegeben werden dürfen. Bei Verstößen drohen Rechtsfolgen.

El copyright de estas instrucciones operativas es propiedad de Interpump Group.

Las instrucciones contienen descripciones técnicas e ilustraciones que no pueden ser copiadas electrónicamente ni reproducidas de modo parcial o total, así como pasadas a terceras partes de cualquier forma y sin la autorización por escrito de la propiedad. Los infractores serán procesados de acuerdo a la ley con las medidas adecuadas.

Os direitos autorais destas instruções operacionais são de propriedade da Interpump Group.

As instruções contêm descrições técnicas e ilustrações que não podem ser eletronicamente copiadas ou reproduzidas inteiramente ou em parte, nem repassar a terceiros de qualquer forma sem autorização por escrito da proprietária. Os infratores serão processados de acordo com a lei, com as ações apropriadas.

I dati contenuti nel presente documento possono subire variazioni senza preavviso.

The data contained in this document may change without notice.

Les données contenues dans le présent document peuvent subir des variations sans préavis.

Änderungen an den in vorliegendem Dokument enthaltenen Daten ohne Vorankündigung vorbehalten.

Los datos contenidos en el presente documento pueden sufrir variaciones sin previo aviso.

Os dados contidos no presente documento podem estar sujeitos a alterações, sem aviso prévio.



Pratissoli

A brand of INTERPUMP GROUP S.p.A.

42049 S. Ilario—Reggio Emilia (Italy)

Tel. +39-0522-904311

Fax +39-0522-904444

E-mail : info@pratissolipompe.com

<http://www.pratissolipompe.com>



INTERPUMP GROUP

**AZIENDA CON SISTEMA
DI GESTIONE QUALITÀ
CERTIFICATO DA DNV
= ISO 9001 =**

Cod. 71980603/2 - Cod.IE 2860000007/2 - 31/01/2013